



Operating and Maintenance Manual

Omega 8 Hydraulic Winch

English

OM 914319-0226-D



CAUTION

READ AND UNDERSTAND THIS MANUAL BEFORE INSTALLATION AND OPERATION OF WINCH. SEE WARNINGS.

Mailing Address:
P.O. Box 58151
Tulsa, OK 74158

Phone: (918) 438-2760
Fax: (918) 438-6688
www.ramseyindustries.com

Congratulations!

You have purchased the finest winch available in its service class. It features a reliable single stage planetary gear set which transmits torque from a geroler type hydraulic motor. A safe positive clutch allows free spooling for quick cable deployment. An automatic load holding brake is designed to hold the full rated capacity of the winch. It was designed and manufactured to provide you with the utmost in utility. As with any device that combines power and movement in its use, there are dangers if improperly used. At the same time, there are easier and faster ways for getting the job done if certain precautions are taken first. Please read this manual carefully. It contains useful ideas in obtaining the most efficient operation from your Ramsey Winch and safety procedures you need to know before beginning use. When you follow our guidelines for operation, your Ramsey Winch will give you many years of satisfying service. Thank you for choosing Ramsey. You will be glad you have one working for you.

Table of Contents

SECTION		PAGE
1	Introduction	2
2	Specifications	3
3	Hydraulic System General Layout and Winch Installation	4
4	Bolt Length Warning	5
5	Cable Installation - Set Screw	6
6	Hydraulic Winch Operation	7
7	Hydraulic Winch Maintenance	8
8	Troubleshooting Guide	9
9	Dimensional Drawing	10
10	Kits and Maintenance Parts	12











1 Introduction

Please read this manual carefully. This manual contains information to obtain the most efficient operation from your Ramsey Winch and safety procedures you need to know before operating a Ramsey Winch. Do not operate this winch until you have carefully read and understand the entire manual.

Ramsey Winches are designed and built to exacting specifications. Great care and skill go into every winch we make. Refer to the last page for information on the Ramsey Winch limited warranty.

At the time of publishing, this manual is accurate to the best of our knowledge. Ramsey Winch reserves the right to change any or all items, components and parts, necessary for any reason. This right does not obligate Ramsey Winch to immediately update the manual. If in doubt, please call your local Ramsey Winch distributor for the most up-to-date information.

Warnings

-  **WARNING** Ensure that the clutch is fully engaged before starting the winching operation.
-  **WARNING** Do not start the winch motor before engaging the clutch.
-  **WARNING** Do not disengage the clutch under load.
-  **WARNING** Do not allow personnel under or near the raised load.
-  **WARNING** Do not try to guide the cable during a pull. Stand clear of the cable.
-  **WARNING** Do not exceed the maximum line pull ratings shown in specifications.
-  **WARNING** Do not use the winch to lift, support, or otherwise transport people.
-  **WARNING** Always maintain a minimum of five wraps of cable around the drum. This is necessary to hold the load. The cable anchor is not designed to hold the load.
-  **WARNING** In car carrier applications, after pulling the vehicle onto the carrier, secure the vehicle to the carrier bed. Do not maintain load on winch cable while transporting the vehicle. Do not use the winch as a tie down.
-  **WARNING** When pulling a heavy load, place a blanket, jacket, or tarpaulin over the cable five or six feet from the hook.
-  **WARNING** Do not allow the load to shift or jerk.

2 Specifications

Performance Table (Omega 8,000)

Rated Line Pull (lbs.).....		8,000			
(Kgs.).....		3,629			
Gear Reduction.....		5.1:1			
Weight (without cable).....		126 lb. (57.15 Kgs.)			
LAYER OF CABLE		1	2	3	4
*Rated line pull per layer	Lbs.	8,000	6,815	5,936	5,258
	Kg.	3,629	3,091	2,693	2,385
*Cable capacity	Ft.	26	57	93	133
	M.	8.1	17.5	28.4	40.6
*Line speed (at 17 GPM)	FPM	52	60	68	76
	MPM	15.7	18.2	20.6	23.1
* These specifications are based on recommended 3/8" (10mm) EIPS wire rope & 15.2 cu.in/Rev. motor at 2000 psi working pressure.					
* Directional control valve: 3-position, 4 way cylinder spool.					
* Winch meets SAE J706.					

Performance Charts (Omega 8,000)

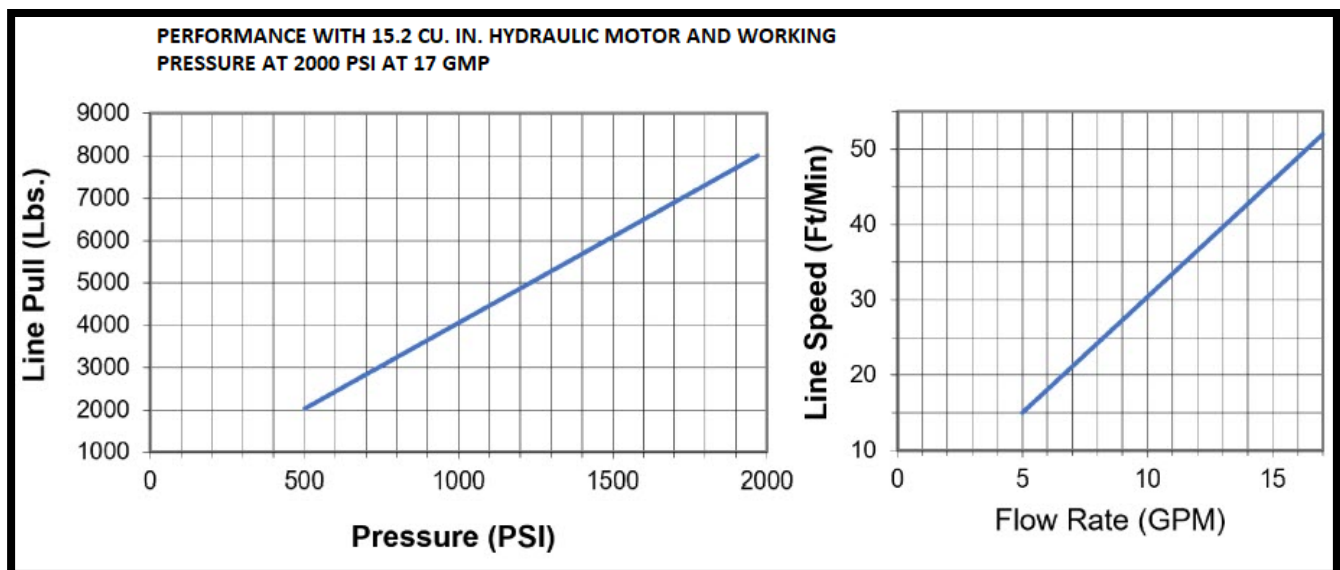

3 Hydraulic System Layout and Winch Installation

Hydraulic System General Layout

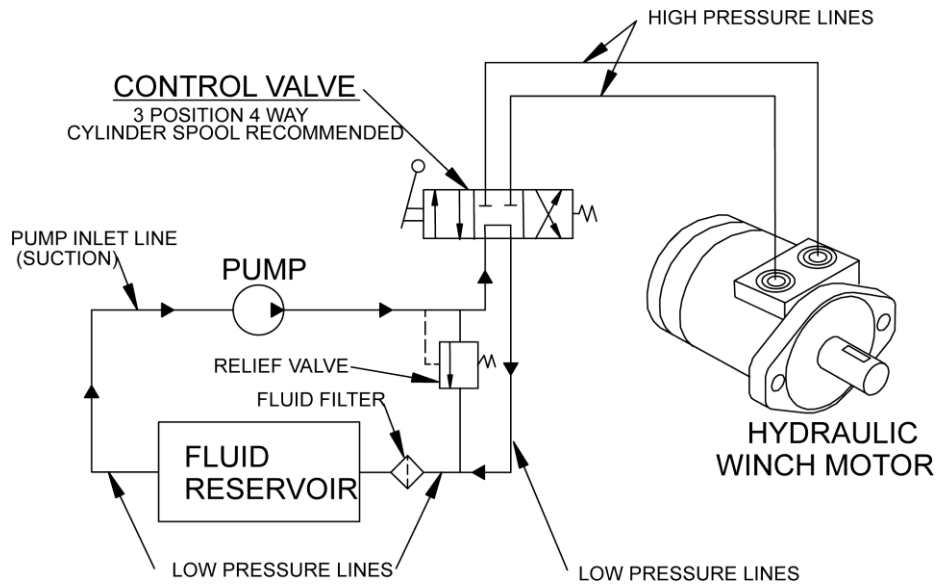

Mounting

It is important to mount the winch securely so the three major sections (the motor end, the cable drum, and the gear housing end) are properly aligned. Excessive bushing wear and difficulty freespooling are usually symptoms of misalignment.

If the winch is mid-mounted, attach at least one tie-plate to the mounting feet at the bottom of the winch to maintain alignment. If the winch is foot mounted, attach at least one tie-plate at the midpoint to maintain alignment. It is always preferred to use both tie-plates in the final installed configuration.

Contact your local RAMSEY WINCH distributor or RAMSEY WINCH customer service for the recommended mounting kit. The mounting kit will allow the winch to be mounted in upright or midmount applications and meets the criteria of serving as a solid and true mounting surface.

If not using the RAMSEY WINCH mounting kit, or a RAMSEY WINCH mounting kit is not available, use the mounting hole patterns described in the Dimensional drawings. The mounting surface must be flat within 0.015 in. and sufficiently stiff to resist flexing.

NOTICE

If angles or a steel plate are used in mounting the winch, attach the provided tie plates to the remaining mounting pads to either the side or foot.

Hydraulic Connection

Prior to attaching hydraulic lines to Control Valve, ensure that the shipping O-rings have been removed from the Control Valve hydraulic ports.

4 Bolt Length Warning

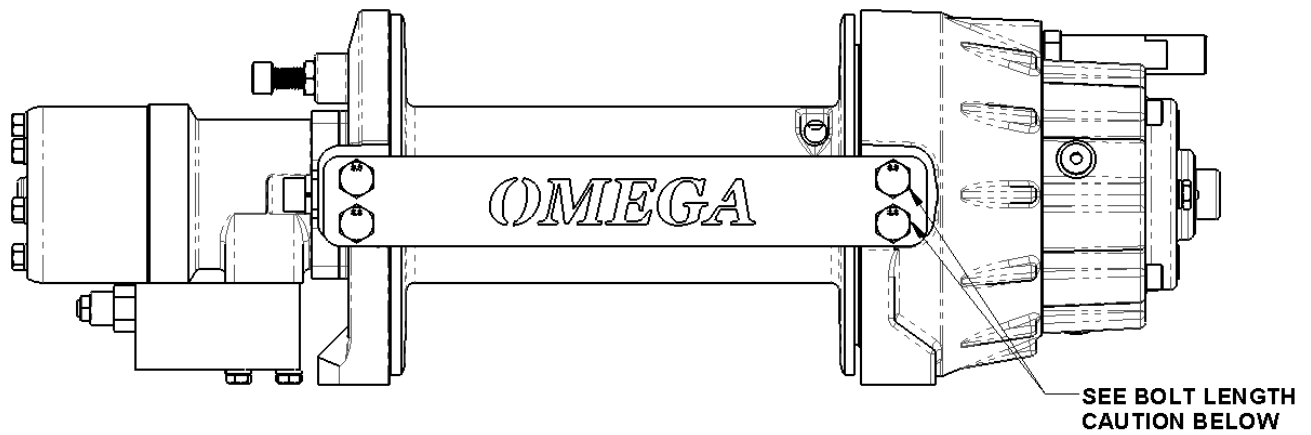

Caution:

If longer bolts (minimum grade 8.8) are substituted to mount winch or to mount a roller guide at side mount pads, bolt length must be such as to allow a maximum of 0.5 inch thread length engagement in the tapped holes in sides of each end bearing. Use of longer bolts will damage the winch and prevent free spool of the drum.

5 Cable Installation – Set Screw

An “A” or “B” decal on the motor end bearing indicates the spooling direction of the cable. If the decal is damaged or unreadable, contact Customer Service for addition information.

1. Unwind the cable by rolling it out along the ground to prevent kinking. Securely wrap the end of the cable opposite of the hook with plastic or similar tape to prevent fraying.
2. Place the taped end of the cable into the hole in cable drum. Use the 3/8-16 NC x 1/2” long hex socket drive setscrew to secure the cable to the drum. The setscrew is included with the drum assembly.
3. Carefully run the winch in the “reel-in” direction. Keeping tension on the end of the cable, spool all the cable onto the cable drum, taking care to form neatly wrapped layers.
4. With the cable installed, check the freespool operation. Disengage the clutch and pull on the cable at a walking speed. If the cable “birdnests,” loosen the jam nut and turn the capscrew clockwise to increase drag on the drum. If the cable pull is excessive, loosen the capscrew by turning counterclockwise. Tighten the jam nut when the proper setting is obtained.

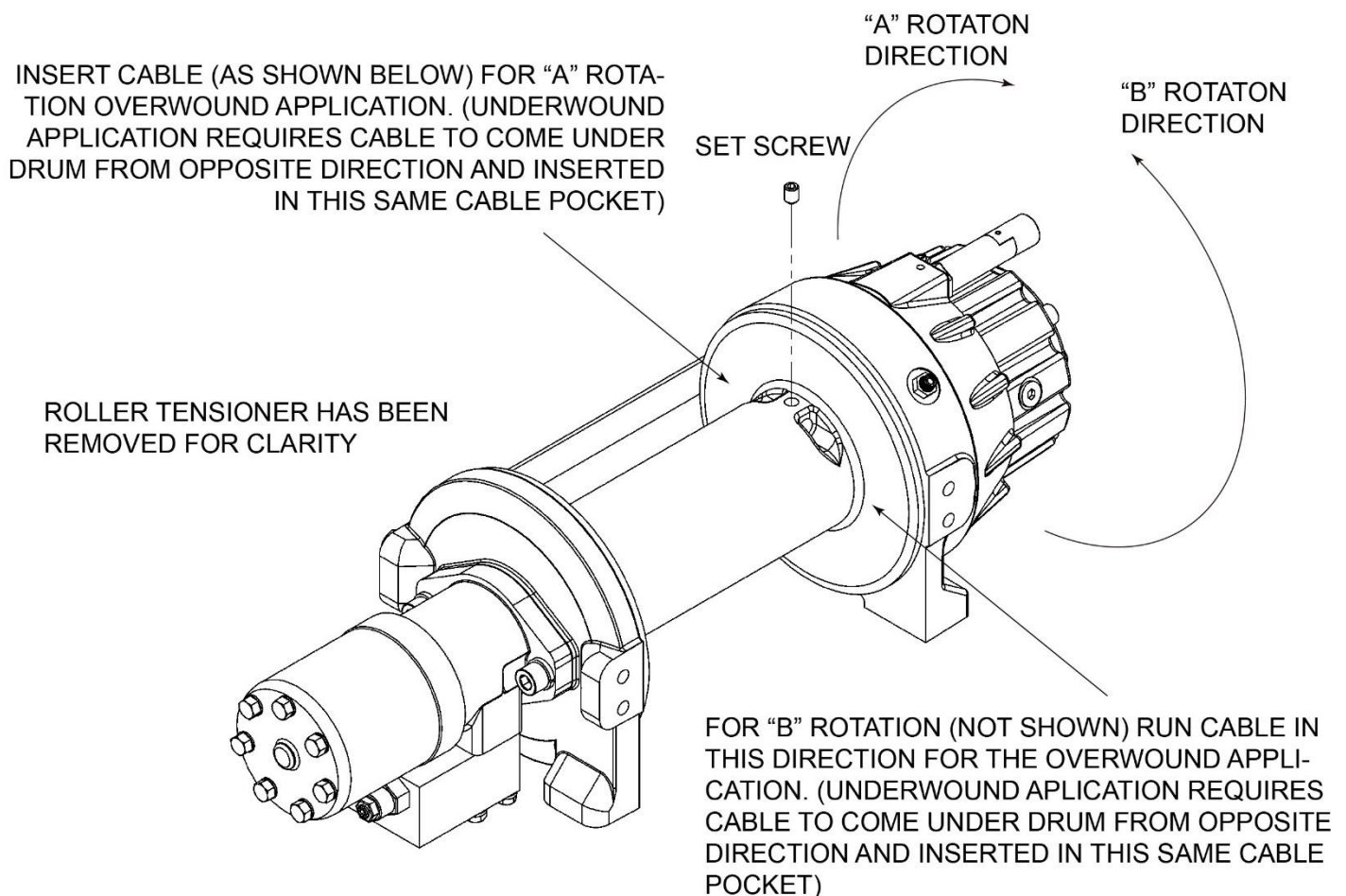

6 Hydraulic Winch Operation

Familiarize yourself with winch by making test runs before the first pull. Plan your test in advance. You hear your winch as well as see it operate; learn to recognize the sounds of a light steady pull, a heavy pull, and sounds caused by load jerking or shifting. Gain confidence in operating your winch and its use will become second nature with you.

The uneven spooling of cable while pulling a load is not a problem unless there is a cable pileup on one end of the drum. If this happens, reverse the winch to relieve the load and move your anchor point closer to the center of the vehicle. After the job is done you can unspool and rewind to neatly lay the cable.



Do not disengage clutch under load.
Clutch must be fully engaged before operating under load.

Manual Clutch Operation

To disengage the clutch:

1. Run the winch in the "cable out" direction until the load is off the cable.
2. Pull the handle out and rotate 90°.
3. With the handle in the "DISENGAGED" position the cable can now be free-spooled from the drum.

To engage the clutch:

1. Pull the handle out and rotate 90° and release the handle.
2. Run the winch in reverse until the clutch handle snaps fully into the "ENGAGED" position and the drum begins to rotate.
3. Do not attempt to pull a load unless the handle is fully at the "ENGAGED" position.
4. Do not force the handle or hammer the handle to engage.

Air Clutch Operation

To disengage the clutch:

1. Run the winch in the reverse (reel out) direction until the load is off the cable.
2. Apply air pressure to the 0.125-27 NPT port. 80 PSI (min.) 150 PSI (max.). Pressure must not exceed 150 PSI.

To engage the clutch:

1. Remove air pressure from the cylinder (a return spring engages the plunger).
2. Run the winch in reverse until the clutch engages and the drum begins to rotate. Do not attempt to pull a load with the clutch not engaged.

7 Hydraulic Winch Maintenance

Maintenance

1. Inspect the cable for damage and lubricate frequently. If the cable becomes frayed with broken strands, replace immediately.
2. When respooling cable, avoid letting cable pile up to one side in order to avoid possible damage to tensioner.
3. Check that the clutch is fully engaging. See OPERATION instructions for the appropriate clutch shifter.

FOR MANUAL CLUTCH ONLY: Monthly, disengage clutch, put several drops of oil on the clutch handle shaft and work clutch handle IN and OUT several times to lubricate inside the shifter assembly.

4. Check to see that the drum cable does not overrun ("birdnest") when freespooling. Contact Ramsey Winch for detailed instructions regarding how to adjust the drag brake.

8 Troubleshooting Guide

CONDITIONS	POSSIBLE CAUSE	CORRECTION
Drum Will Not Rotate With No Load	<ol style="list-style-type: none"> 1. Winch not mounted squarely causing end bearings to bind the drum. 2. Brake damaged. 3. Gears damaged. 	<ol style="list-style-type: none"> 1. Check the mounting. Verify it's square. 2. Inspect and replace brake. 3. Inspect and replace damaged gears.
Drum Will Not Rotate Under Load	<ol style="list-style-type: none"> 1. Load greater than rated capacity of the winch. 2. Low hydraulic system pressure. 3. Winch not mounted squarely causing end bearings to bind the drum. 	<ol style="list-style-type: none"> 1. Reduce load to less than the rated capacity of the winch. 2. Check pressure. 3. Check the mounting. Verify it's square.
Winch Runs Too Slow	<ol style="list-style-type: none"> 1. Low flow rate. 2. Hydraulic motor worn out. 	<ol style="list-style-type: none"> 1. Check flow rate. 2. Replace motor.
Drum Will Not Freespool	<ol style="list-style-type: none"> 1. Clutch not disengaged. 2. Winch not mounted squarely causing end bearings to bind the drum. 	<ol style="list-style-type: none"> 1. Disengage clutch. 2. Check the mounting. Verify it's square.
Brake Will Not Hold	<ol style="list-style-type: none"> 1. Brake damaged. 	<ol style="list-style-type: none"> 1. Inspect and replace brake.
Load Drifts	<ol style="list-style-type: none"> 1. Worn brake. 	<ol style="list-style-type: none"> 1. Overhaul the brake assembly.
Cable Birdnests When The Clutch is Disengaged	<ol style="list-style-type: none"> 1. Drag screw improperly adjusted. 	<ol style="list-style-type: none"> 1. Adjust drag screw.
Excessive Noise	<ol style="list-style-type: none"> 1. Hydraulic system flow too high. 2. Drum in bind, winch not mounted squarely. 	<ol style="list-style-type: none"> 1. Check flow rate. 2. Check the mounting. Verify it's square.
Drum Chatters in "Reel In" Direction	<ol style="list-style-type: none"> 1. Low hydraulic system flow. 2. Low hydraulic system relief pressure setting. 	<ol style="list-style-type: none"> 1. Check flow rate. 2. Check relief valve setting.
Clutch Difficult to Engage	<ol style="list-style-type: none"> 1. Detent screw damaged or improperly adjusted. 	<ol style="list-style-type: none"> 1. Replace or readjust detent screw.
Oil Leakage	<ol style="list-style-type: none"> 1. Damaged brake housing gasket or breather. 2. Damaged brake hub seal. 	<ol style="list-style-type: none"> 1. Replace gasket and check for plugged breather. 2. Replace the seal.
Load Drifts	<ol style="list-style-type: none"> 1. Brake needs adjustment. 	<ol style="list-style-type: none"> 1. Contact factory for detailed brake adjustment instructions.

9 Dimensional Drawing

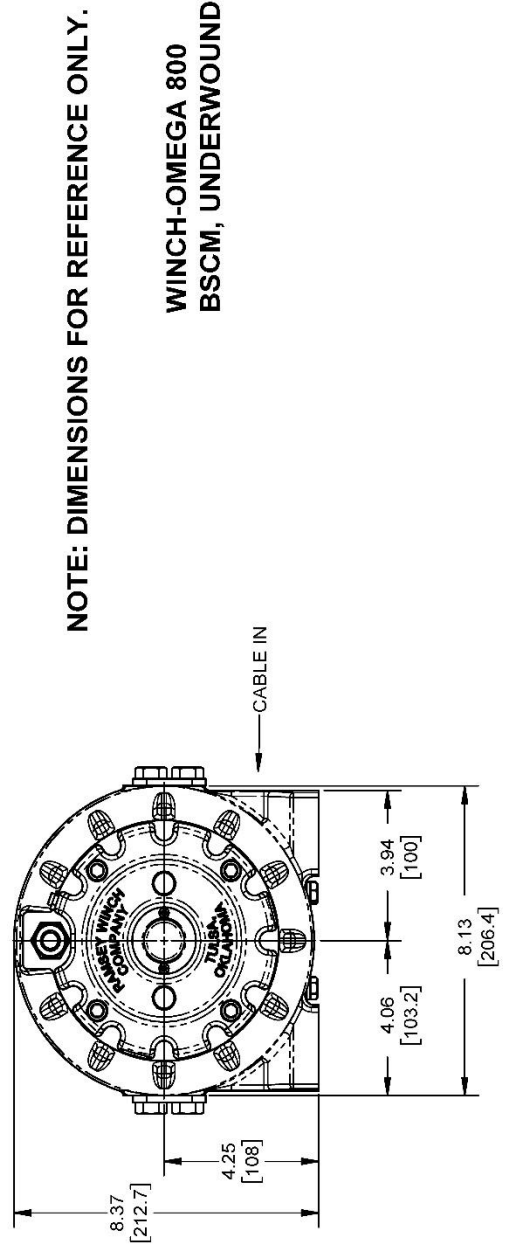
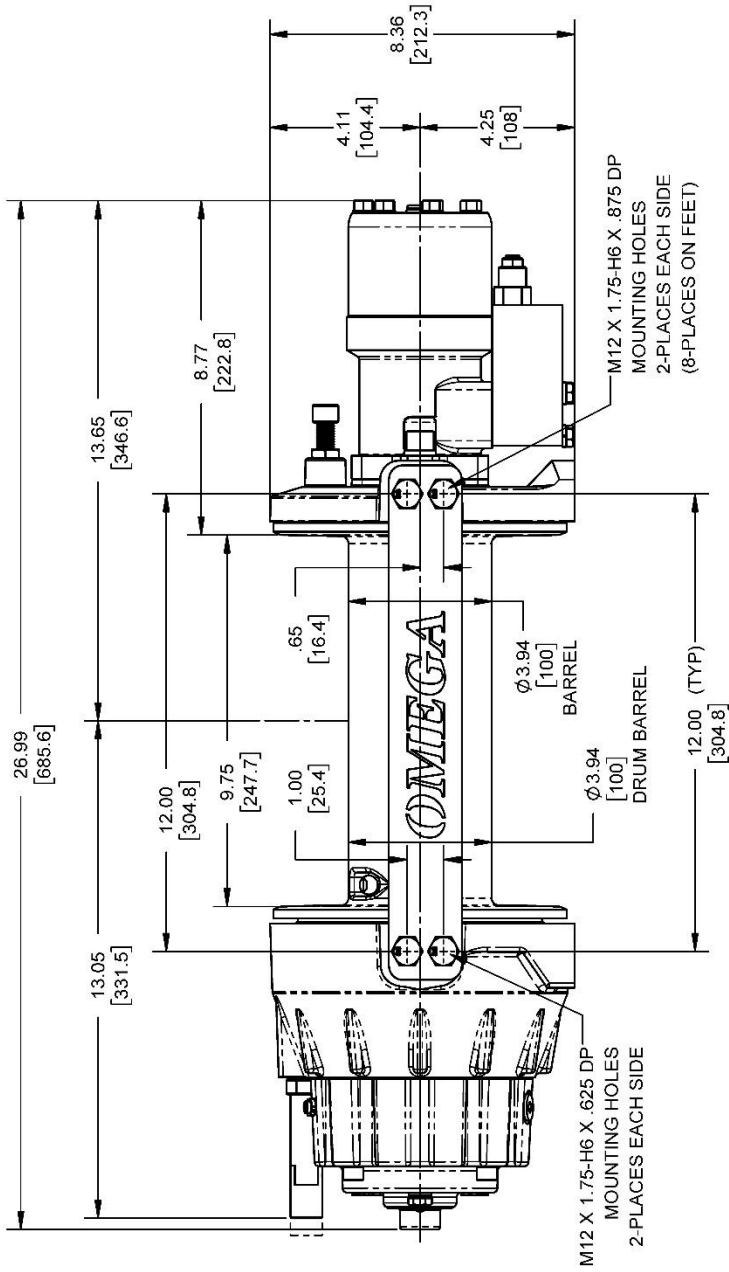

14 KITS AND MAINTENANCE PARTS

129100

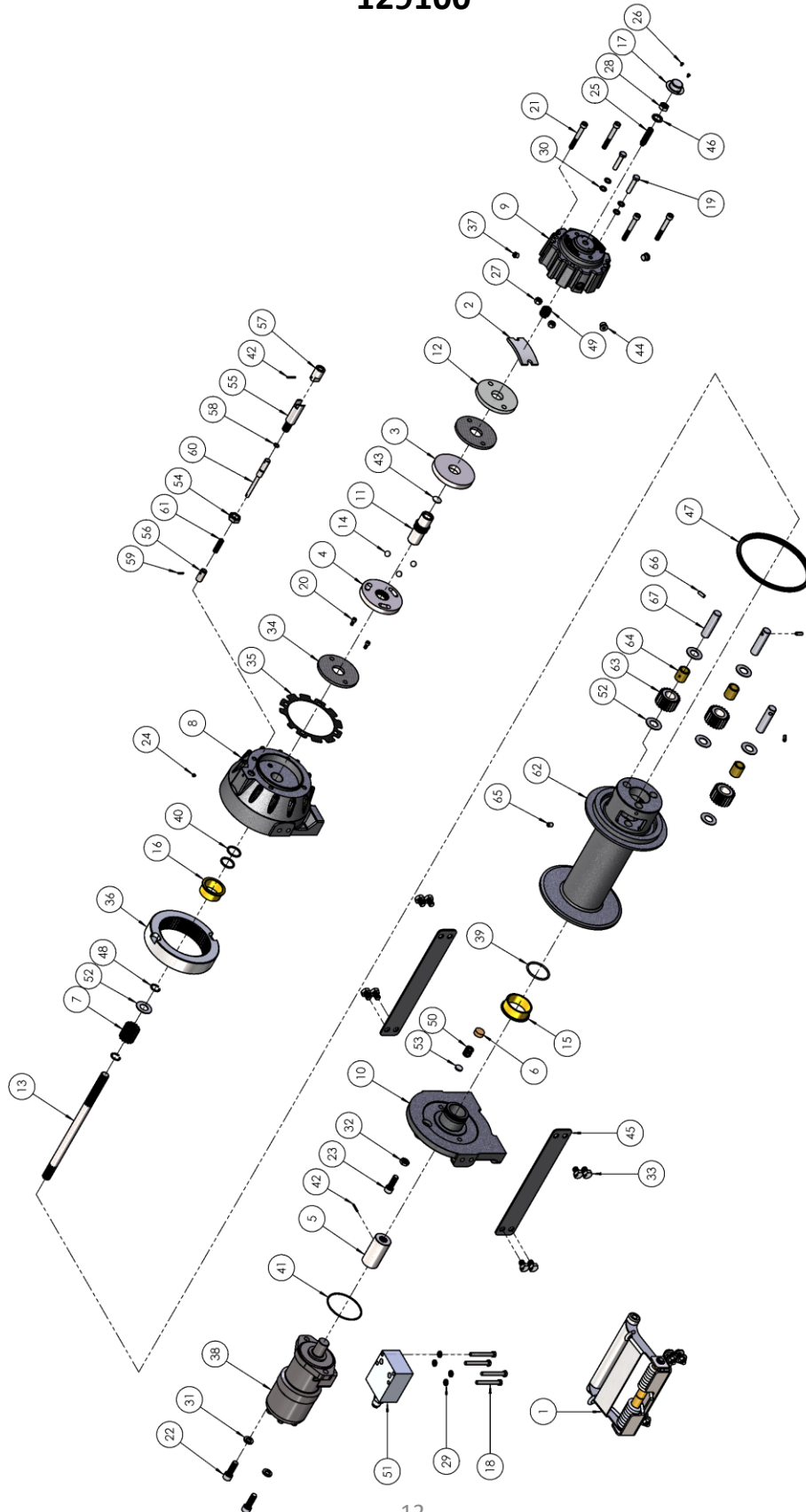

KITS AND MAINTENANCE PARTS 14

129100

Item#	QTY.	PART NUMBER	DESCRIPTION	KITS						
				207040	207057	222070	246074	248052	283083	293033
1	1	297129	ASSEMBLY-SPRING ROLLER TENSIONER							
2	1	306035	SPRING-FLT	X						
3	1	314018	CAM PLATE							
4	1	314019	HUB PLATE		X					
5	1	324296	COUPLING						X	
6	1	330010	SHOE-DRAG							
7	1	334174	GEAR-OUTPUT,SUN							
8	1	338488	END BEARING-GEAR HOUSING							
9	1	338489	BRAKE HOUSING							
10	1	338501	END BEARING-MOTOR END							
11	1	340077	SHAFT-BRAKE		X					
12	1	352021	RETAINER PLATE	X						
13	1	357495	SHAFT-INPUT							
14	3	400007	BALL-1/2 DIA	X						
15	1	412084	BUSHING-DRUM,MOTOR END					X		
16	1	412085	BUSHING-DRUM,GEAR END					X		
17	1	413148	COVER-TAMPER PROOF							
18	4	414159	CS-5/16-18UNCX2.50,HXHD,GR5							
19	2	414273	BOLT-3/8-16NCX1 3/4,HXHD,GR5							
20	2	414836	CAPSCREW-1/4-20NCX1/2,HXSOCHD							
21	4	414934	CAPSCREW-3/8-16NCX2 3/4,HXSOCHD							
22	2	414952	CAPSCREW-1/2-13NCX1 1/2LG,SOCHD							
23	1	415410	CAPSCREW-M12 X 1.75 X 35mm, SOCKET HEAD							
24	1	416016	SETSCREW1/4-20NCX1/4 HX SOCK HD CUP			X				
25	1	416304	SETSCREW-1/2-13UNC X 2 LG							
26	2	416305	CAPSCREW-BUTTON HEAD,#6-32UNC X .25L							
27	2	418035	NUT-3/8-16NC HEX REG							
28	1	418061	NUT-1/2-13NC,HEX							
29	4	418163	LOCKWASHER-5/16							
30	4	418184	WASHER-3/8ID X5/8 ODX1/16							
31	2	418218	LOCKWASHER-1/2 ID							
32	1	418546	NUT-JAM, M12 X 1.75							
33	8	420050	CAPSCREW-M12 X 1.75 X 16MM LG, HXHD, GR 8.8							
34	2	438066	DISC-BRAKE	X						
35	1	442241	GASKET-BRAKE HOUSING				X			
36	1	444140	GEAR-RING							
37	1	456008	RELIEF FIT-1/8-27PFT							
38	1	458074	MOTOR-HYD							
39	1	462046	O-RING 1/8X2 1/4 OD X 2				X			
40	2	462047	QUAD-RING,1.174 ID				X			

14 KITS AND MAINTENANCE PARTS

129100

Item#	QTY.	PART NUMBER	DESCRIPTION	KITS						
				207040	207057	222070	246074	248052	283083	293033
41	1	462048	O-RING				X		X	
42	2	470033	SPIROL PIN-1/8X7/8			X			X	
43	1	472051	PLUG-FREEZE		X					
44	2	472052	PLUG-SAE O-RING,.562-18NF							
45	2	474282	TIE PLATE							
46	1	486076	SEAL-1/2				X			
47	1	486080	SEAL-GH				X			
48	2	490003	SNAP RING							
49	1	494010	SPRING-14 GAX7/8 ODX3/4LG	X						
50	1	494154	SPRING							
51	1	516009	VALVE-MTR							
52	7	518047	WASHER-THRUST,.063 THK.X1.50 OD					X		X
53	1	518099	DISC-THRUST							
54	1	418088	NUT-JAM 5/8-18NF HEX HD			X				
55	1	426041	CYLINDER			X				
56	1	426042	PLUNGER			X				
57	1	431082	COUPLING-SHIFTER			X				
58	1	462045	O-RING-1/16X1/2OD X3/8ID			X	X			
59	1	470088	PIN-SPRING			X				
60	1	489015	SHAFT-SHIFTER			X				
61	1	494104	SPRING-SHIFTER			X				
62	1	332302	DRUM							X
63	3	334173	GEAR-OUTPUT,PLANET							X
64	3	412089	BUSHING-PLANET,OUTPUT							X
65	1	416059	SETSCREW3/8-16NCX1/2 HX SOCK HD CUP							
66	3	470086	ROLL PIN-1/4 X 11/16LG							X
67	3	470090	PIN-PLANET							X

KITS AND MAINTENANCE PARTS 14

129105

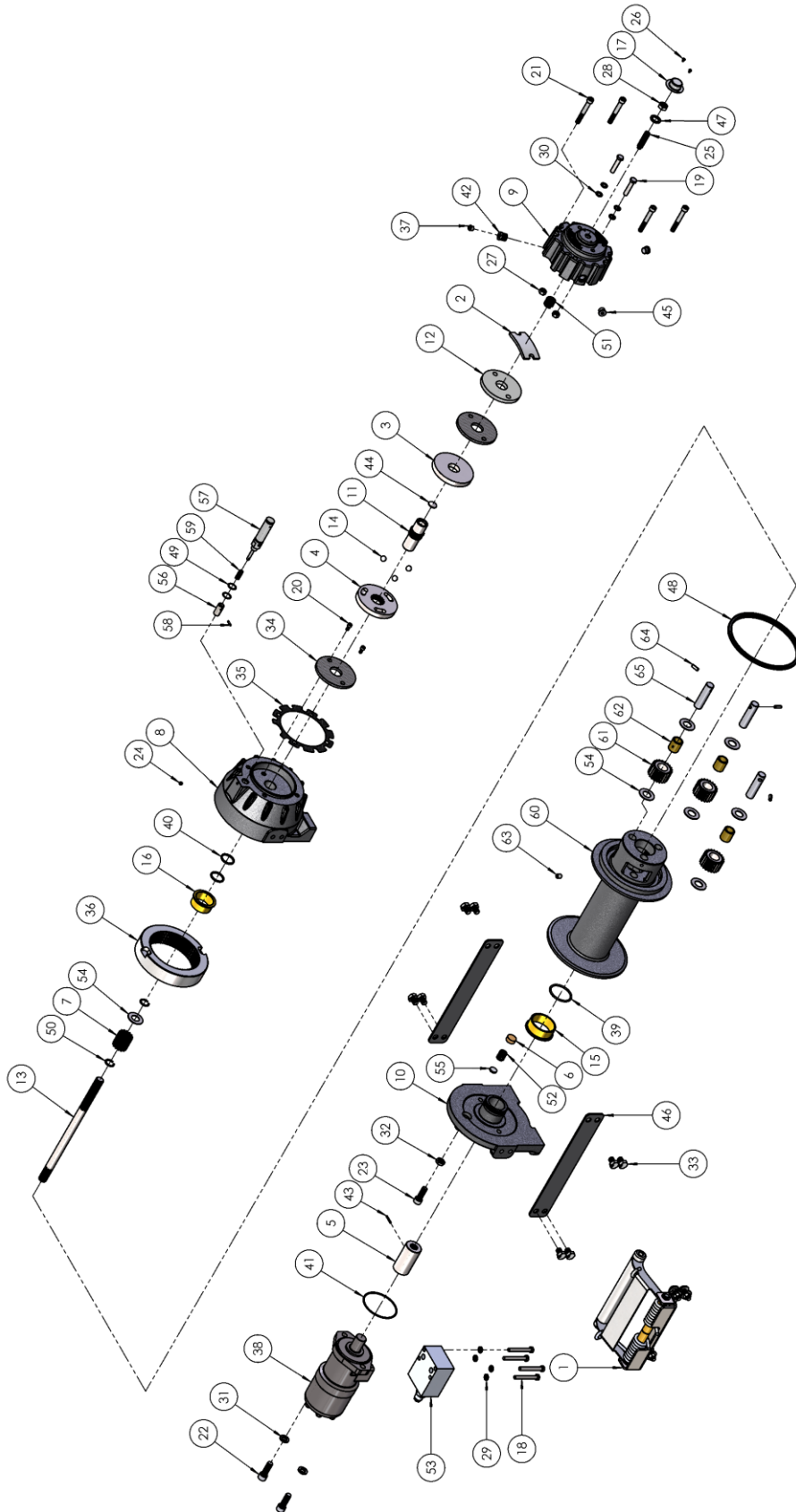

14 KITS AND MAINTENANCE PARTS

129105

Item#	QTY.	PART NUMBER	DESCRIPTION	KITS						
				207040	207057	222071	246074	248052	283083	293033
1	1	297129	ASSEMBLY-SPRING ROLLER TENSIONER							
2	1	306035	SPRING-FLT	X						
3	1	314018	CAM PLATE							
4	1	314019	HUB PLATE		X					
5	1	324296	COUPLING						X	
6	1	330010	SHOE-DRAG							
7	1	334174	GEAR-OUTPUT,SUN							
8	1	338488	END BEARING-GEAR HOUSING							
9	1	338489	BRAKE HOUSING							
10	1	338501	END BEARING-MOTOR END							
11	1	340077	SHAFT-BRAKE		X					
12	1	352021	RETAINER PLATE	X						
13	1	357495	SHAFT-INPUT							
14	3	400007	BALL-1/2 DIA	X						
15	1	412084	BUSHING-DRUM,MOTOR END					X		
16	1	412085	BUSHING-DRUM,GEAR END					X		
17	1	413148	COVER-TAMPER PROOF							
18	4	414159	CS-5/16-18UNCX2.50,HXHD,GR5							
19	2	414273	BOLT-3/8-16NCX1 3/4,HXHD,GR5							
20	2	414836	CAPSCREW-1/4-20NCX1/2,HXSOCHD							
21	4	414934	CAPSCREW-3/8-16NCX2 3/4,HXSOCHD							
22	2	414952	CAPSCREW-1/2-13NCX1 1/2LG,SOCHD							
23	1	415410	CAPSCREW-M12 X 1.75 X 35mm, SOCKET HEAD							
24	1	416016	SETSCREW1/4-20NCX1/4 HX SOCK HD CUP			X				
25	1	416304	SETSCREW-1/2-13UNC X 2 LG							
26	2	416305	CAPSCREW-BUTTON HEAD,#6-32UNC X .25L							
27	2	418035	NUT-3/8-16NC HEX REG							
28	1	418061	NUT-1/2-13NC,HEX							
29	4	418163	LOCKWASHER-5/16							
30	4	418184	WASHER-3/8ID X5/8 ODX1/16							
31	2	418218	LOCKWASHER-1/2 ID							
32	1	418546	NUT-JAM, M12 X 1.75							
33	8	420050	CAPSCREW-M12 X 1.75 X 16MM LG, HXHD, GR 8.8							
34	2	438066	DISC-BRAKE	X						
35	1	442241	GASKET-BRAKE HOUSING				X			
36	1	444140	GEAR-RING							
37	1	456008	RELIEF FIT-1/8-27PFT							
38	1	458074	MOTOR-HYD							
39	1	462046	O-RING 1/8X2 1/4 OD X 2				X			
40	2	462047	QUAD-RING,1.174 ID				X			

KITS AND MAINTENANCE PARTS 14

129105

Item#	QTY.	PART NUMBER	DESCRIPTION	KITS						
				207040	207057	222071	246074	248052	283083	293033
41	1	462048	O-RING				X		X	
42	1	468002	RED-3/8-1/8NPTF							
43	1	470033	SPIROL PIN-1/8X7/8						X	
44	1	472051	PLUG-FREEZE		X					
45	2	472052	PLUG-SAE O-RING,.562-18NF							
46	2	474282	TIE PLATE							
47	1	486076	SEAL-1/2				X			
48	1	486080	SEAL-GH				X			
49	3	488007	SHIM-AIR CYLINDER							
50	2	490003	SNAP RING							
51	1	494010	SPRING-14 GAX7/8 ODX3/4LG	X						
52	1	494154	SPRING							
53	1	516009	VALVE-MTR							
54	7	518047	WASHER-THRUST,.063 THK.X1.50 OD					X		X
55	1	518099	DISC-THRUST							
56	1	426042	PLUNGER			X				
57	1	433027	AIR CYLINDER			X				
58	1	470088	PIN-SPRING			X				
59	1	494103	SPRING-SHIFTER			X				
60	1	332302	DRUM							X
61	3	334173	GEAR-OUTPUT,PLANET							X
62	3	412089	BUSHING-PLANET,OUTPUT							X
63	1	416059	SETSCREW3/8-16NCX1/2 HX SOCK HD CUP							
64	3	470086	ROLL PIN-1/4 X 11/16LG							X
65	3	470090	PIN-PLANET							X

14 KITS AND MAINTENANCE PARTS

129114

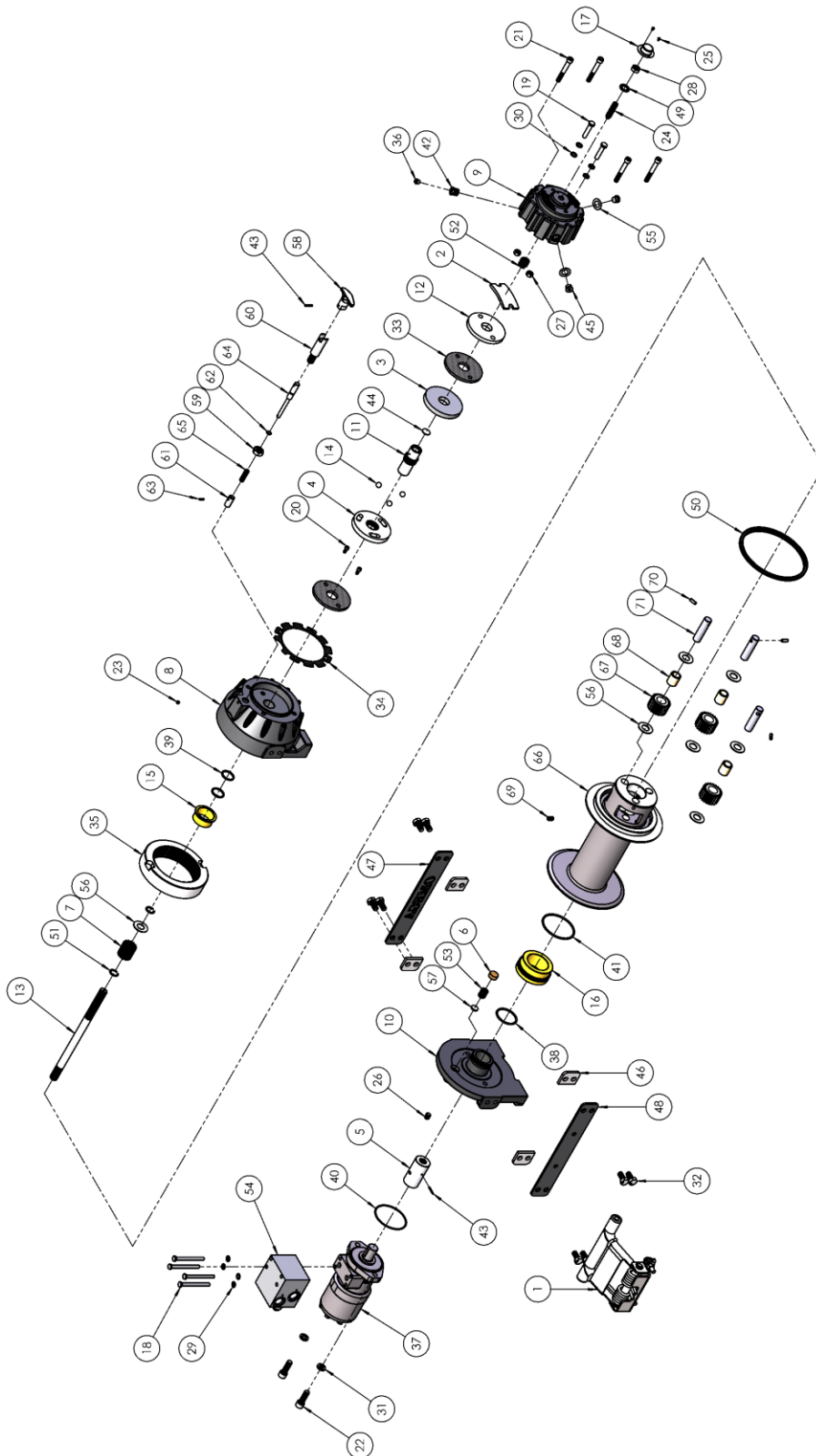

KITS AND MAINTENANCE PARTS 14

129114

Item#	QTY.	PART NUMBER	DESCRIPTION	KITS						
				207040	207057	222069	246073	248053	283083	293032
1	1	299813	ASSEMBLY-SPRING ROLLER TENSIONER							
2	1	306035	SPRING-FLT	X						
3	1	314017	CAM PLATE							
4	1	314019	HUB PLATE		X					
5	1	324296	COUPLING						X	
6	1	330010	SHOE-DRAG							
7	1	334174	GEAR-OUTPUT,SUN							
8	1	338488	END BEARING-GEAR HOUSING							
9	1	338489	BRAKE HOUSING							
10	1	338501	END BEARING-MOTOR END							
11	1	340077	SHAFT-BRAKE		X					
12	1	352021	RETAINER PLATE	X						
13	1	357599	SHAFT-INPUT							
14	3	400007	BALL-1/2 DIA	X						
15	1	412085	BUSHING-DRUM,GEAR END					X		
16	1	412202	BUSHING-DRUM					X		
17	1	413148	COVER-TAMPER PROOF							
18	4	414147	CAPSCREW-5/16-18NCX3-1/2 HXHD G5							
19	2	414273	BOLT-3/8-16NCX1 3/4,HXHD,GR5							
20	2	414836	CAPSCREW-1/4-20NCX1/2,HXSOCHD							
21	4	414934	CAPSCREW-3/8-16NCX2 3/4,HXSOCHD							
22	2	414952	CAPSCREW-1/2-13NCX1 1/2LG,SOCHD							
23	1	416016	SETSCREW1/4-20NCX1/4 HX SOCK HD			X				
24	1	416304	SETSCREW-1/2-13UNC X 2 LG							
25	2	416305	CAPSCREW-BUTTON HEAD #6-32UNC X .25L							
26	1	416307	SETSCREW-12M X 1.75 X 14MM LONG							
27	2	418035	NUT-3/8-16NC HEX REG							
28	1	418061	NUT-1/2-13NC,HEX							
29	4	418163	LOCKWASHER-5/16							
30	4	418184	WASHER-3/8ID X5/8 ODX1/16							
31	2	418218	LOCKWASHER-1/2 ID							
32	8	420029	CAPSCREW-M12 X 1.75 X 25MM LG, HXHD, GR 8.8							
33	2	438066	DISC-BRAKE	X						
34	1	442241	GASKET-BRAKE HOUSING				X			
35	1	444140	GEAR-RING							
36	1	456008	RELIEF FIT-1/8-27PFT							
37	1	458074	MOTOR-HYD							
38	1	462046	O-RING 1/8X2 1/4 OD X 2				X			
39	2	462047	QUAD-RING,1.174 ID				X			
40	1	462048	O-RING				X		X	

14 KITS AND MAINTENANCE PARTS

129114

Item#	QTY.	PART NUMBER	DESCRIPTION	KITS						
				207040	207057	222069	246073	248053	283083	293032
41	1	462073	O-RING-3.234 ID X .139 THK				X			
42	1	468002	RED-3/8-1/8NPTF							
43	2	470033	SPIROL PIN-1/8X7/8			X			X	
44	1	472051	PLUG-FREEZE		X					
45	2	472052	PLUG-SAE O-RING,.562-18NF							
46	4	474274	SPACER-TIE PLATE							
47	1	474278	TIE PLATE							
48	1	474279	TIE PLATE							
49	1	486076	SEAL-1/2				X			
50	1	486080	SEAL-GH				X			
51	2	490003	SNAP RING							
52	1	494010	SPRING-14 GAX7/8 ODX3/4LG,1/4 PITCH	X						
53	1	494154	SPRING-DRAG BRAKE							
54	1	516029	VALVE-MTR CONT							
55	2	518037	THRUST WASHER							
56	7	518047	WASHER-THRUST,.063 THK.X1.50 OD					X		X
57	1	518099	DISC-THRUST							
58	1	336026	HANDLE-SHIFTER			X				
59	1	418088	NUT-JAM 5/8-18NF HEX HD			X				
60	1	426041	CYLINDER-CLUTCH			X				
61	1	426042	PLUNGER-CLUTCH			X				
62	1	462045	O-RING-1/16X1/2OD X3/8ID			X	X			
63	1	470088	PIN-SPRING			X				
64	1	489015	SHAFT-SHIFTER			X				
65	1	494104	SPRING-SHIFTER			X				
66	1	332301	DRUM							X
67	3	334173	GEAR-OUTPUT,PLANET							X
68	3	412083	BUSHING-PLANET,OUTPUT							X
69	1	416294	SETSCREW3/8-16NCX5/8 HX SOCK HD CUP							
70	3	470086	ROLL PIN-1/4 X 11/16LG							X
71	3	470090	PIN-PLANET							X

KITS AND MAINTENANCE PARTS 14

129115

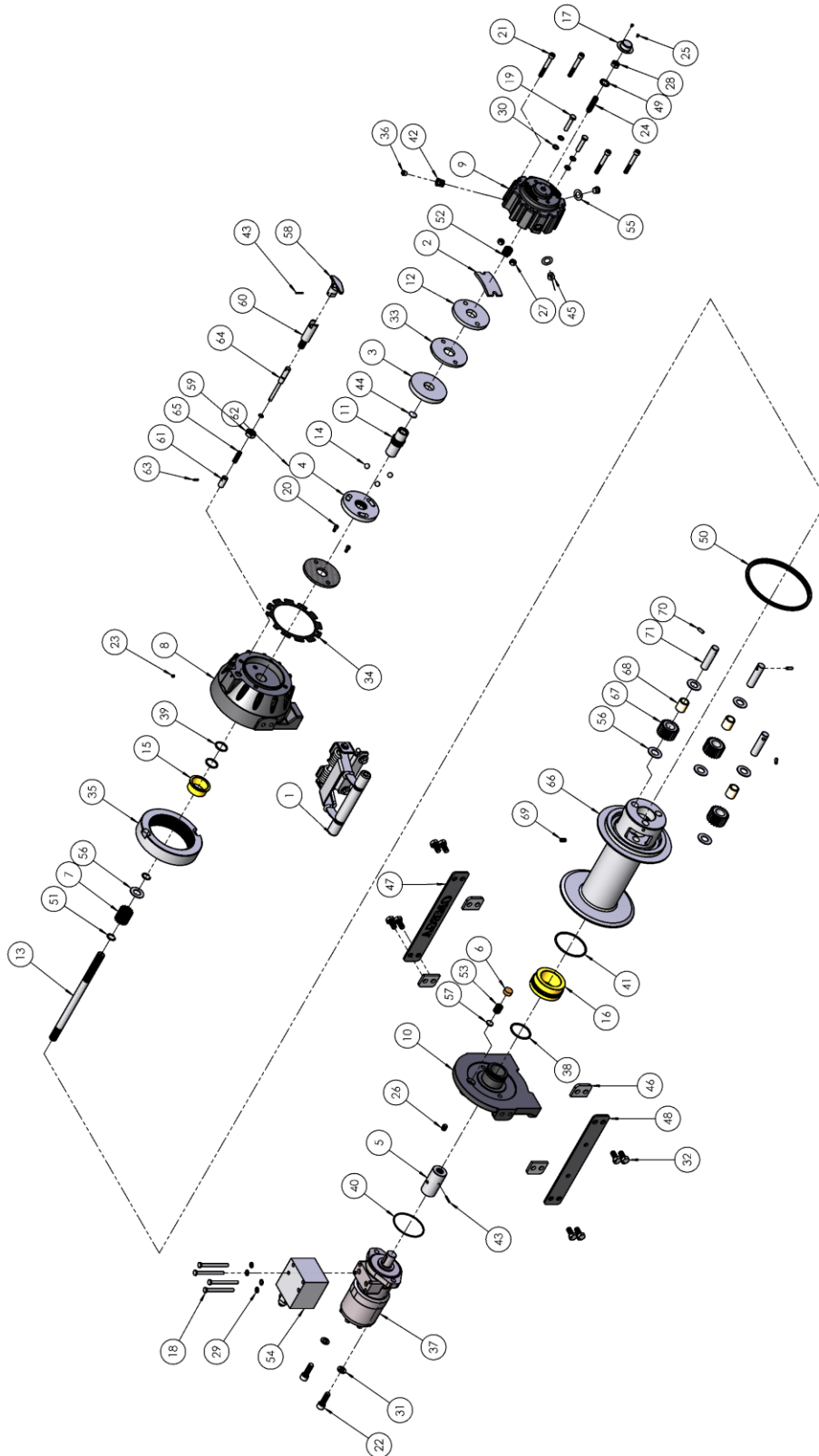

14 KITS AND MAINTENANCE PARTS

129115

Item#	QTY.	PART NUMBER	DESCRIPTION	KITS						
				207040	207057	222069	246073	248053	283083	293032
1	1	299813	ASSEMBLY-SPRING ROLLER TENSIONER							
2	1	306035	SPRING-FLT	X						
3	1	314018	CAM PLATE							
4	1	314019	HUB PLATE		X					
5	1	324296	COUPLING						X	
6	1	330010	SHOE-DRAG							
7	1	334174	GEAR-OUTPUT,SUN							
8	1	338488	END BEARING-GEAR HOUSING							
9	1	338489	BRAKE HOUSING							
10	1	338501	END BEARING-MOTOR END							
11	1	340077	SHAFT-BRAKE		X					
12	1	352021	RETAINER PLATE	X						
13	1	357599	SHAFT-INPUT							
14	3	400007	BALL-1/2 DIA	X						
15	1	412085	BUSHING-DRUM,GEAR END					X		
16	1	412202	BUSHING-DRUM					X		
17	1	413148	COVER-TAMPER PROOF							
18	4	414147	CAPSCREW-5/16-18NCX3-1/2 HXHD G5							
19	2	414273	BOLT-3/8-16NCX1 3/4,HXHD,GR5							
20	2	414836	CAPSCREW-1/4-20NCX1/2,HXSOCHD							
21	4	414934	CAPSCREW-3/8-16NCX2 3/4,HXSOCHD							
22	2	414952	CAPSCREW-1/2-13NCX1 1/2LG,SOCHD							
23	1	416016	SETSCREW1/4-20NCX1/4 HX SOCK HD			X				
24	1	416304	SETSCREW-1/2-13UNC X 2 LG							
25	2	416305	CAPSCREW-BUTTON HEAD #6-32UNC X .25L							
26	1	416307	SETSCREW-12M X 1.75 X 14MM LONG							
27	2	418035	NUT-3/8-16NC HEX REG							
28	1	418061	NUT-1/2-13NC,HEX							
29	4	418163	LOCKWASHER-5/16							
30	4	418184	WASHER-3/8ID X5/8 ODX1/16							
31	2	418218	LOCKWASHER-1/2 ID							
32	8	420029	CAPSCREW-M12 X 1.75 X 25MM LG, HXHD, GR 8.8							
33	2	438066	DISC-BRAKE	X						
34	1	442241	GASKET-BRAKE HOUSING				X			
35	1	444140	GEAR-RING							
36	1	456008	RELIEF FIT-1/8-27PFT							
37	1	458074	MOTOR-HYD							
38	1	462046	O-RING 1/8X2 1/4 OD X 2				X			
39	2	462047	QUAD-RING,1.174 ID				X			
40	1	462048	O-RING				X		X	

KITS AND MAINTENANCE PARTS 14

129115

Item#	QTY.	PART NUMBER	DESCRIPTION	KITS						
				207040	207057	222069	246073	248053	283083	293032
41	1	462073	O-RING-3.234 ID X .139 THK				X			
42	1	468002	RED-3/8-1/8NPTF							
43	2	470033	SPIROL PIN-1/8X7/8			X			X	
44	1	472051	PLUG-FREEZE		X					
45	2	472052	PLUG-SAE O-RING,.562-18NF							
46	4	474274	SPACER-TIE PLATE							
47	1	474278	TIE PLATE							
48	1	474279	TIE PLATE							
49	1	486076	SEAL-1/2				X			
50	1	486080	SEAL-GH				X			
51	2	490003	SNAP RING							
52	1	494010	SPRING-14 GAX7/8 ODX3/4LG,1/4 PITCH	X						
53	1	494154	SPRING-DRAG BRAKE							
54	1	516030	VALVE-MOTOR CONTROL							
55	2	518037	THRUST WASHER							
56	7	518047	WASHER-THRUST,.063 THK.X1.50 OD					X		X
57	1	518099	DISC-THRUST							
58	1	336026	HANDLE-SHIFTER			X				
59	1	418088	NUT-JAM 5/8-18NF HEX HD			X				
60	1	426041	CYLINDER-CLUTCH			X				
61	1	426042	PLUNGER-CLUTCH			X				
62	1	462045	O-RING-1/16X1/2OD X3/8ID			X	X			
63	1	470088	PIN-SPRING			X				
64	1	489015	SHAFT-SHIFTER			X				
65	1	494104	SPRING-SHIFTER			X				
66	1	332301	DRUM							X
67	3	334173	GEAR-OUTPUT,PLANET							X
68	3	412083	BUSHING-PLANET,OUTPUT							X
69	1	416294	SETSCREW3/8-16NCX5/8 HX SOCK HD CUP							
70	3	470086	ROLL PIN-1/4 X 11/16LG							X
71	3	470090	PIN-PLANET							X

**RAMSEY WINCH INDUSTRIAL WINCH
LIMITED WARRANTY**

1.1 Scope of Warranty Coverage. Upon the terms and subject to the conditions set forth in this limited warranty:

- (a) RAMSEY WINCH (referred to herein as “**RAMSEY WINCH**” or the “**Manufacturer**”) warrants to each initial end user customer (a “**Purchaser**”) of a new industrial winch together with any accessories manufactured and sold directly from RAMSEY WINCH (the “**Product**”) that the Product shall be free from defects in material and workmanship, under normal working and service conditions, for a period of eighteen (18) months from the date the Product is shipped from RAMSEY WINCH. (the “**Warranty Term**”). A Purchaser shall be eligible for an additional eighteen (18) months of coverage in addition to the Warranty Term (also referred to as the “**Standard (+) PLUS benefit**”) only if the Purchaser (i) complies with Section 1.2(a) and (ii) registers the Product during the Warranty Term at myproduct.ramseywinch.com.
- (b) Notwithstanding the foregoing, this warranty does not cover components damaged by accident, abuse, misuse, neglect, untrained operators, collision, overloading, modification, disassembly, rework, misapplication, improper installation, lack of lubrication or maintenance, or improper service. This warranty does not cover the paint or material finish, rope (wire or synthetic), removal or reinstallation of the winch, or normal wear and tear and loss of functionality due to aging of the Product (which may include but is not limited to bearings, bushings, seals, O-rings, gaskets, brake material, motor brushes, electrical cables and more).

1.2 Eligibility of Warranty Coverage.

- (a) A Purchaser shall be eligible for warranty coverage under this Limited Warranty during the Warranty Term only if:
 - (i) Prior to placing a Product in service, and throughout use of the Product during the Warranty Term, the Purchaser provides (or causes to be provided) proper storage such that foreign objects (e.g. rain or debris) cannot enter any Product through entry ports which are normally closed during operation.; and
 - (ii) The Purchaser maintains, or causes to be maintained, the Product according to commercially reasonable standards and utilizes the Product for the purposes for which it was created; and
 - (iii) No repairs or alterations have been made by any party other than RAMSEY WINCH, including Purchaser, unless otherwise authorized in writing by RAMSEY WINCH.

1.3 Transferability of Warranty.

- (a) This warranty is transferable only from the Purchaser to the first subsequent transferee (the “**Transferee**”) of the Product from Purchaser upon (i) written notification to RAMSEY WINCH and (ii) registration of the transfer, both within 30 days of such Product transfer.
- (b) Upon satisfaction of transfer requirements set forth in Section 1.3(a), the Transferee shall succeed to all the rights and obligations of the Purchaser set forth in this Limited Warranty.

1.4 Certain Limitations on Scope of Warranty Service.

- (a) Any obligation of RAMSEY WINCH under this warranty, statutory or otherwise, is limited to the repair of the Product, at its factory or Authorized Service Centers. Notwithstanding the foregoing, if field service or repair is performed by RAMSEY WINCH at the request of the Purchaser and no defect is found with material or workmanship of the Product, the Purchaser shall compensate RAMSEY WINCH for its time and expenses within thirty (30) days of delivery of an invoice relating to the same. If repair is determined by RAMSEY WINCH in its sole, absolute and uncontrolled discretion to be impossible or impractical, then RAMSEY WINCH may satisfy this warranty by replacing the Product. RAMSEY WINCH will not provide any cash payment or credits for defective materials or workmanship.

- (b) Purchaser shall be responsible for any and all freight charges for any Product receiving warranty service under this limited warranty. Any travel time, transportation charges, freight charges, or similar costs incurred by RAMSEY WINCH in connection with the replacement or repair of defective parts, shall, be the responsibility of the Purchaser. If applicable, RAMSEY WINCH shall invoice Purchaser for the total amount of such charges within sixty (60) days of fulfilling its duties under this warranty, payable within thirty (30) days of delivery of such invoice. In no event shall RAMSEY WINCH be liable for bills for service, labor or other expenses that have been incurred by the Purchaser without approval or prior authorization by RAMSEY WINCH for inspection, maintenance, or repair of the Product.
- (c) If a Product is found to be operable upon inspection, the Product, at Purchaser's election, may be either (1) returned to the Purchaser with a service charge from RAMSEY WINCH for inspection, cleaning, and routine replacement of all rubber components and any other parts that show wear; or (2) RAMSEY WINCH can dispose of the product safely.

1.5 **Limitations of Liability.** RAMSEY WINCH shall in no event be liable for punitive, special or consequential damages relating to the Product or this Warranty. RAMSEY WINCH makes no warranty in respect to third-party accessories, upgrades, or additions to the Product.

1.6 **Improving Product.** RAMSEY WINCH reserves the right to improve the Product through changes in design or materials as it may deem desirable or necessary without being obligated to incorporate, upgrade, or otherwise modify previously manufactured products.

1.7 **Limitations of Warranty.**

- (a) THE WARRANTY SET FORTH ABOVE IS THE ONLY EXPRESS WARRANTY. RAMSEY WINCH HEREBY DISCLAIMS AND EXCLUDES ANY OTHER EXPRESS, IMPLIED, OR STATUTORY WARRANTIES, ARISING BY OPERATION OF LAW, COURSE OF DEALING, COURSE OF PERFORMANCE, USAGE, OF TRADE, OR OTHERWISE, INCLUDING, WITHOUT LIMITATION, ANY WARRANTIES OF MERCHANTABILITY, FITNESS FOR A PARTICULAR PURPOSE, AND INTELLECTUAL PROPERTY RIGHTS OF A THIRD PARTY.
- (b) ANY IMPLIED WARRANTY WHICH BY LAW MAY NOT BE EXCLUDED IS LIMITED IN DURATION TO ONE (1) YEAR FROM THE DATE OF ORIGINAL RETAIL PURCHASE OF THE PRODUCT.
- (c) This warranty gives you specific legal rights, and you may also have other rights which vary from jurisdiction to jurisdiction.
- (d) This warranty is valid only in the U.S.A. and Canada. For warranty outside the U.S.A. and Canada contact your nearest Ramsey Winch Distributor.

1.8 **No Modifications to Warranty.** No RAMSEY WINCH dealer, distributor, agent or employee is authorized to make any modification, extension or addition to this warranty.

1.9 **How to Apply for Warranty Coverage.**

All claims are handled by contacting your nearest Ramsey Winch Distributor. For questions, please contact customer support: rwcustomersupport@ramseyindustries.com.

Visit [Dealer Locator - Ramsey Winch](#) for Ramsey Winch Distributor locations and contact information.

Additional warranty, service support, product information, and parts information can be found on www.ramseywinch.com.

