



---

Operating/Service/Maintenance Manual

# SCH 8500 Planetary Winch

OM 914187-0226-H

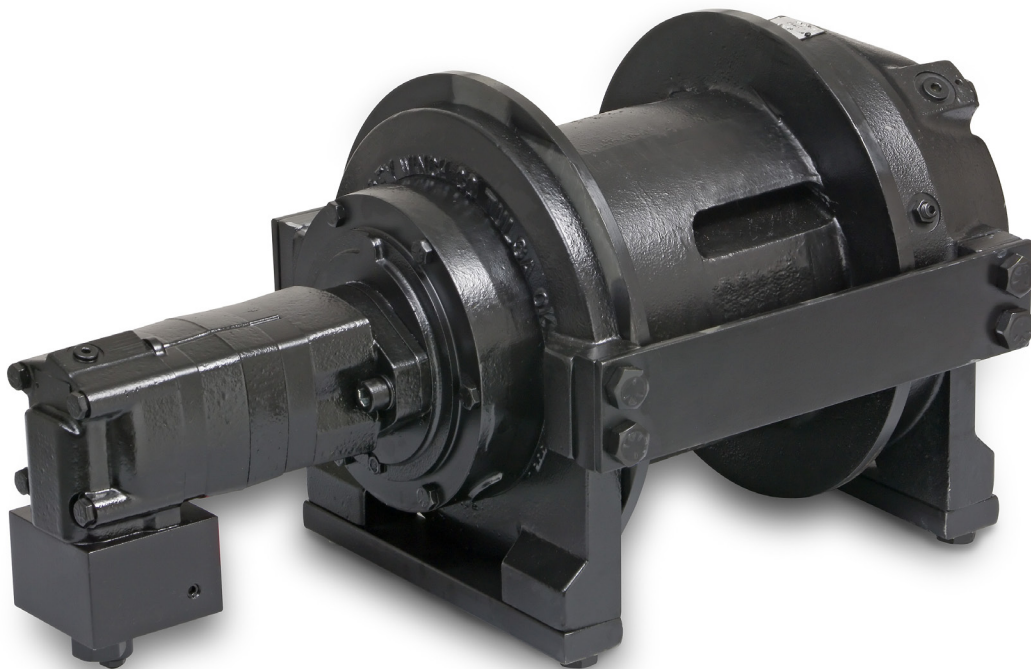

 **CAUTION**

READ AND UNDERSTAND THIS MANUAL BEFORE INSTALLATION AND OPERATION OF WINCH. SEE WARNINGS.

---

Mailing Address:  
P.O. Box 581510  
Tulsa, OK 74158

Phone: (918) 438-2760  
Fax: (918) 438-6688  
[www.ramseyindustries.com](http://www.ramseyindustries.com)

## TABLE OF CONTENTS

INTRODUCTIONS .....	1
WARRANTY INFORMATION.....	1
SPECIFICATIONS .....	1
WARNINGS.....	1
HYDRAULIC SYSTEM REQUIREMENTS .....	2
PERFORMANCE CHARTS.....	3
WINCH MOUNTING .....	4
OPERATION .....	4
MAINTENANCE .....	4
CABLE INSTALLATION .....	4
TROUBLE SHOOTING GUIDE.....	5
DIMENSIONAL DRAWINGS .....	6
PARTS LIST AND PARTS DRAWINGS .....	8-9
LIMITED WARRANTY .....	BACK COVER

**PLEASE READ THIS MANUAL CAREFULLY**

This manual contains useful ideas for obtaining the most efficient operation from your Ramsey Winch, and safety procedures one needs to know before operating a Ramsey Winch. Do not operate this winch until you have carefully read and understand the "WARNING" and "OPERATION" sections of this manual.

**WARRANTY INFORMATION**

Ramsey Winches are designed and built to exacting specifications. Great care and skill go into every winch we make. If the need should arise, warranty procedure is outlined on the back of your self-addressed postage paid warranty card. Please read and fill out the enclosed warranty card and send it to Ramsey Winch Company. If you have any problems with your winch, please follow instructions for prompt service on all warranty claims. Refer to back page for limited warranty.

**SPECIFICATIONS\***

<b>SCH-8500 (18.7 cu.in. Motor)</b>				
Rated Line Pull	(lbs).....	8,500		
	(kg).....	3,850		
Gear Reduction	.....	7.7:1		
Weight (without cable)	.....	257 lbs. (117 kg)		
LAYER OF CABLE		1	2	3
Rated Line Pull	lbs	8500	7600	6900
per Layer	kg	2720	3440	3120
Line Speed	fpm	49	54	59
at 15 GPM	mpm	14	16	18
Cable Capacity	ft	30	65	100
	m	9	19	30

<b>SCH-8500 (14.9 cu.in. Motor)</b>				
Rated Line Pull	(lbs).....	8,500		
	(kg).....	3,850		
Gear Reduction	.....	7.7:1		
Weight (without cable)	.....	257 lbs. (117 kg)		
LAYER OF CABLE		1	2	3
Rated Line Pull	lbs	8500	7600	6900
per Layer	kg	2720	3440	3120
Line Speed	fpm	63	70	77
at 15 GPM	mpm	19	21	23
Cable Capacity	ft	30	65	100
	m	9	19	30

\* These specifications are based on recommended 1/2 in. (12 mm) EIPS wire rope.

**NOTE:** The rated line pulls shown are for the winch only. Consult the wire rope manufacturer for wire rope ratings.

---

**WARNINGS:**

**STAY OUT FROM UNDER AND AWAY FROM RAISED LOADS.**

**STAND CLEAR OF CABLE WHILE PULLING. DO NOT TRY TO GUIDE CABLE.**

**DO NOT EXCEED MAXIMUM LINE PULL RATINGS SHOWN IN TABLE.**

**DO NOT USE WINCH TO LIFT, SUPPORT, OR OTHERWISE TRANSPORT PERSONNEL.**

**A MINIMUM OF 5 WRAPS OF WIRE ROPE AROUND DRUM BARREL IS REQUIRED TO HOLD THE LOAD.**

## HYDRAULIC SYSTEM REQUIREMENTS

Refer to the performance charts on following page to properly match your hydraulic system to the winch performance. The charts consist of:

- (1) First layer Line Pull (LB) vs. Working Pressure (PSI) and
- (2) First layer Line Speed (FPM) vs. Flow (GPM).

A motor spool directional control valve is required.

## TYPICAL LAYOUT

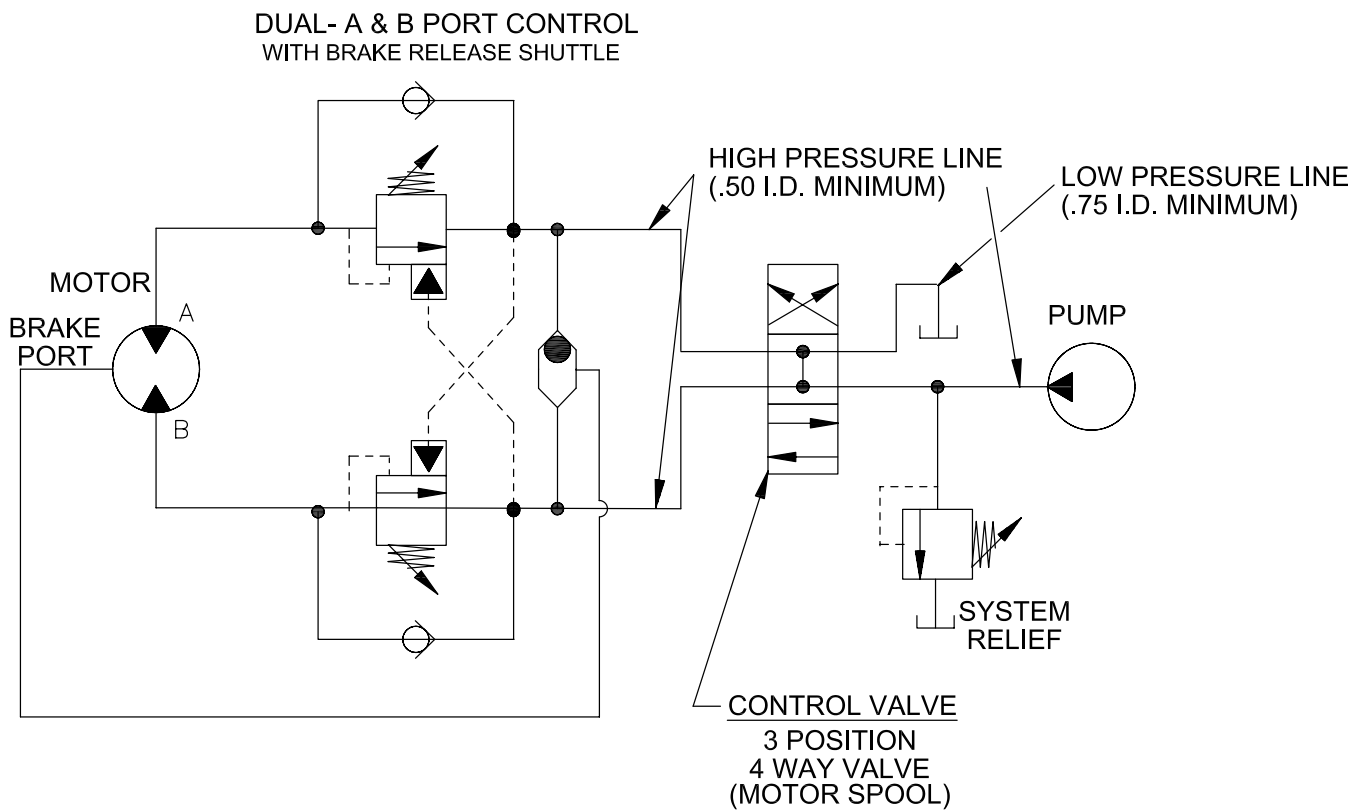

# PERFORMANCE CHARTS

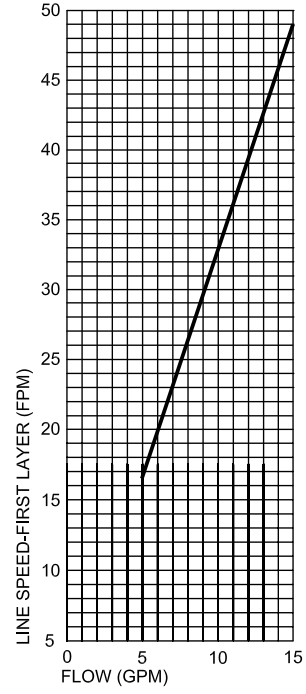
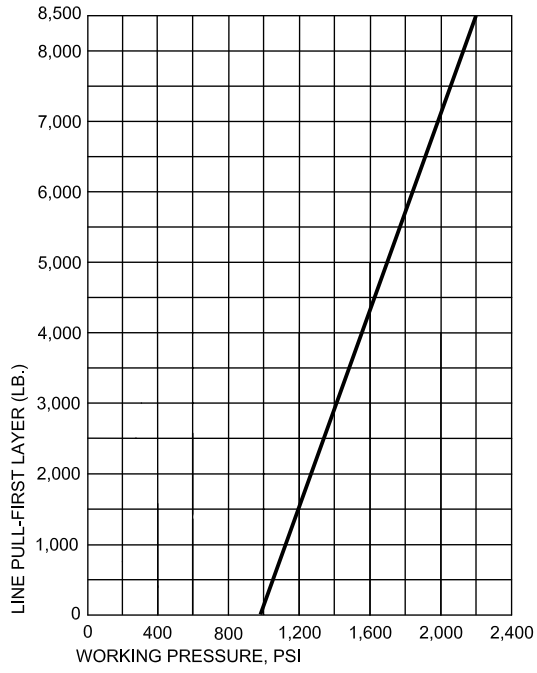

## SCH-8500 (18.7 cu.in. Motor)

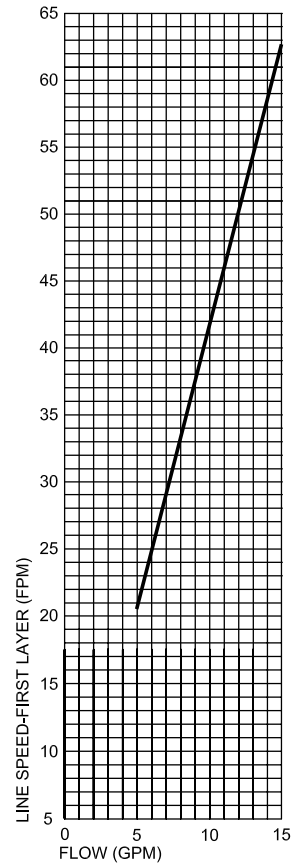
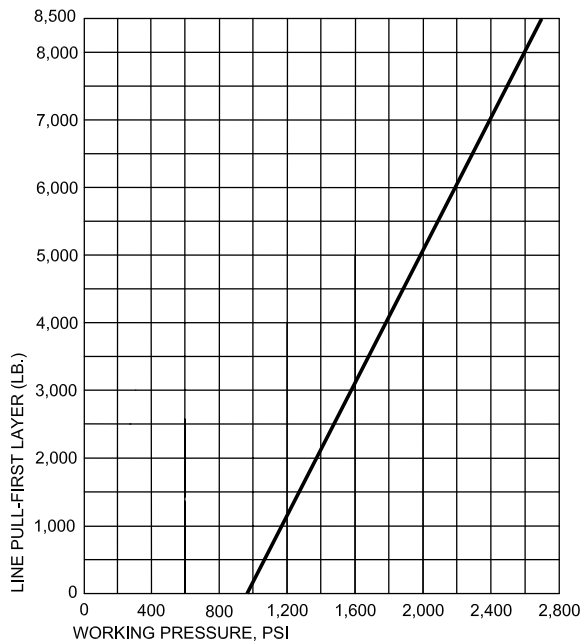

## WINCH MOUNTING

**NOTE: The winch must be mounted so that it reels in in the required direction as noted on page 5.**

**NOTE: Remove and discard the (4) 5/8" capscrews from the foot mounting holes in the end bearings. These capscrews hold on the foot mount spacers during shipping and should not be used for mounting.**

It is most important that this winch be mounted securely so that the three major sections (the motor end, the cable drum, and the gear-housing end) are properly aligned. Excessive bushing wear is a symptom of misalignment.

When installed mid-mounted, at least one tie plate should be attached to the mounting feet at the bottom of the winch to maintain alignment. When installed foot-mounted, at least one tie plate should remain mounted at mid point of winch to maintain alignment. It is always preferable to use both tie plates in the installed configuration.

When mounting the winch, the mounting hole patterns described on page 6 should be used. The mounting surface must be flat within 0.015 inch and sufficiently stiff to resist flexing. If a steel plate is used for foot mounting it should be .750 inch thick. For this mounting application eight (8) 5/8-11NC x 2" Lg. Gr. 5 capscrews with lockwashers will be needed to mount winch. Note that the supplied foot-mount spacers (.50" thick) must be installed between the winch and the mounting plate. Capscrews should be torqued to 173 ft-lb. (235 Nm).

**CAUTION: IF LONGER BOLTS ARE SUBSTITUTED TO MOUNT WINCH OR TO MOUNT A ROLLER GUIDE AT THE SIDE MOUNT PADS, GRADE 5 OR BETTER BOLTS SHOULD ALWAYS BE USED, AND BOLT LENGTH SHOULD BE SUCH THAT A MAXIMUM OF .56 INCH THREAD LENGTH ENGAGEMENT IS ACHIEVED IN THE TAPPED HOLES IN THE SIDES OF EACH END BEARING.**

## OPERATION

The best way to get acquainted with how your winch operates is to make test runs before you actually use it. Plan your test in advance. Remember, you hear your winch, as well as see it operate. Get to recognize the sounds of a light steady pull, a heavy pull, and sounds caused by load jerking or shifting. Avoid conditions where load shifts or jerks occur, as they may indicate a dangerous situation.

The uneven spooling of cable, while pulling a load, is not a problem, unless there is a cable pileup on one end of drum. If this happens, reverse the winch to relieve the load and move your anchor point further to the center of the load. After the job is done you can unspool and rewind for a neat lay of the cable.

## MAINTENANCE

1. Inspect the cable for damage and lubricate frequently. If the cable becomes frayed with broken strands, replace immediately.
2. Replace drum bushings and seals when seals begin to seep grease. Add additional lubricant, Mobilith SHC 007, to gears if required.

## CABLE INSTALLATION

1. Unwind cable by rolling it out along the ground to prevent kinking. Securely wrap end of cable, opposite hook, with plastic or similar tape to prevent fraying.
2. Place taped end of cable into narrow side of pocket on the cable drum. Wrap end of cable around cable anchor or puck and pull tight.
3. Carefully run winch in the "reel-in" direction. Keeping tension on end of cable, spool all the cable onto the cable drum, taking care to form neatly wrapped layers.

## TROUBLESHOOTING GUIDE

<b>CONDITIONS</b>	<b>POSSIBLE CAUSE</b>	<b>CORRECTION/ACTION</b>
DRUM WILL NOT ROTATE AT NO LOAD	Brake damaged	Inspect and replace brake
	Gears damaged	Inspect and replace damaged gears
	Brake not releasing	Brake damaged; inspect and replace.
DRUM WILL NOT ROTATE UNDER LOAD	Load greater than rated capacity of winch	Refer to Specifications page 1 for line pull rating
	Low hydraulic system pressure	Check pressure. Refer to Hydraulic Systems performance charts page 2
WINCH RUNS TOO SLOW	Low hydraulic system flow rate	Check flow rate. Refer to Typical Layout page 2
	Motor worn out	Replace motor
BRAKE WILL NOT RELEASE	Brake damaged	Inspect and replace
EXCESSIVE NOISE	Hydraulic system flow too high	Check flow rate. Refer to Typical Layout page 2
DRUM CHATTERS IN "REEL IN" DIRECTION	Low hydraulic system flow rate	Check flow rate. Refer to Typical Layout page 2
	Low hydraulic system relief pressure setting	Check relief valve setting.
OIL SEEPAGE FROM BREATHER VENT OF BRAKE HOUSING	Brake piston not sealing properly	Replace o-ring and backup o-rings on brake piston

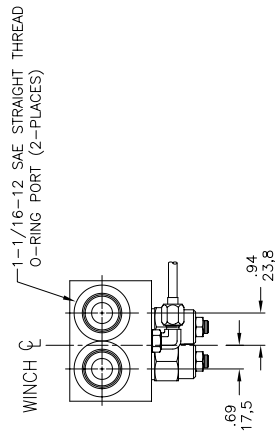
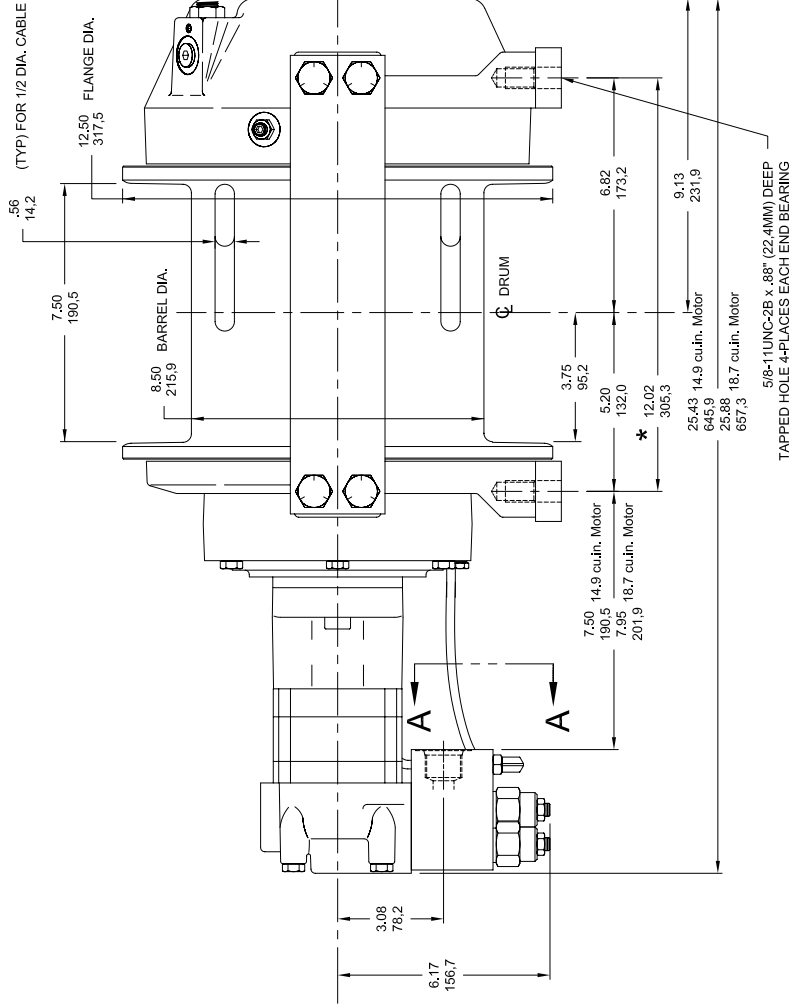

VIEW A-A  
MOTOR CONTROL VALVE DETAIL

NOTE:

\* WINCH MOUNTING CAPSCREWS MUST MEET OR EXCEED SAE GRADE 5 SPECIFICATION  
NOTE: THESE HOLE LOCATIONS MUST BE HELD WITHIN ±.03" (0.8 MM) OF TRUE POSITION. RECOMMENDED MOUNTING HOLE DIAMETER IS .53" (13.5 MM).

DIMENSIONS SHOWN ARE INCHES OVER MILLIMETERS

# SCH-8500

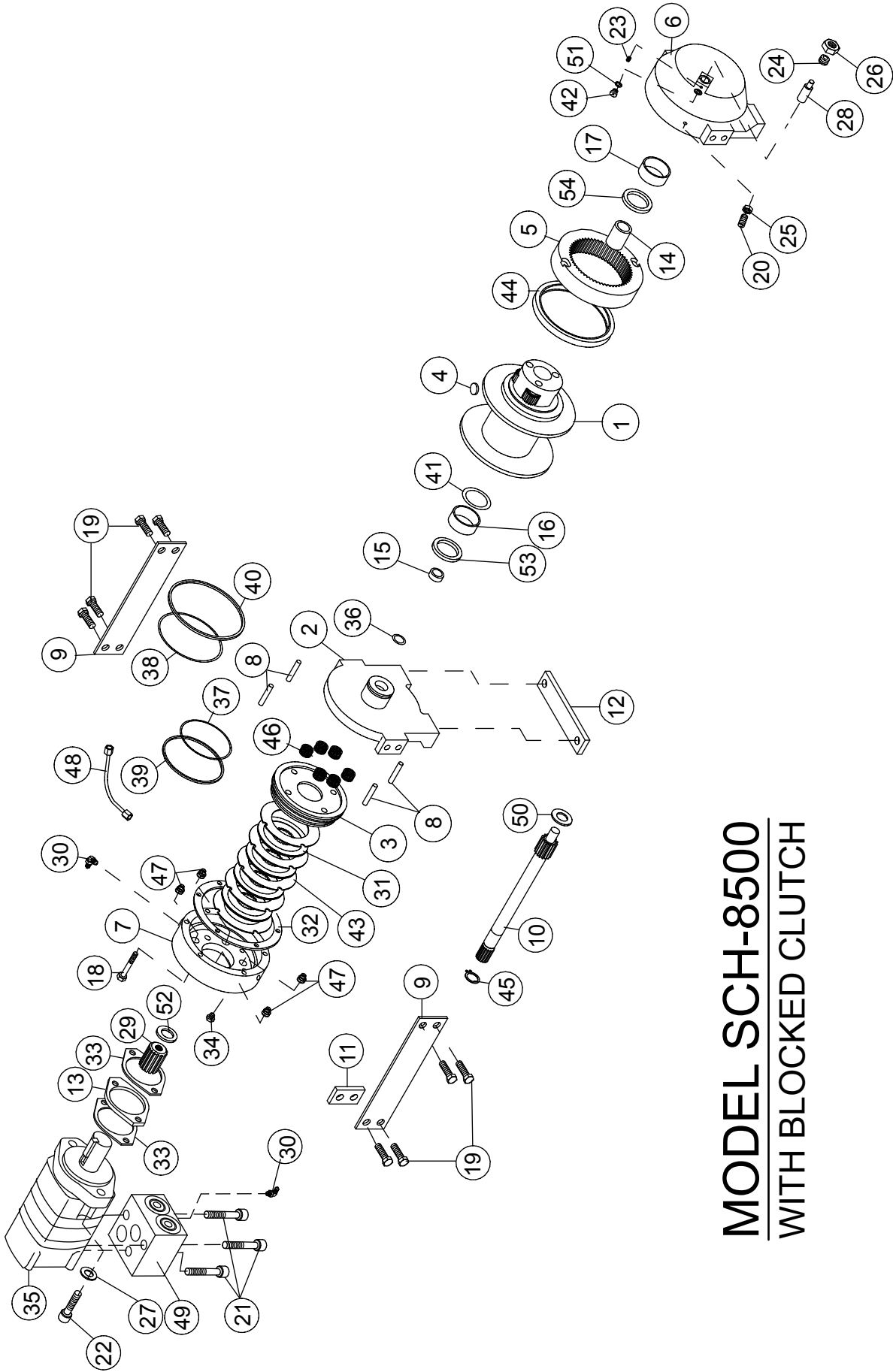

**MODEL SCH-8500**  
**WITH BLOCKED CLUTCH**

# PARTS LIST

Item No.	Quantity	Part No.	Description	Item No.	Quantity	Part No.	Description
1	1	234256	DRUM ASSEMBLY	28	1	426048	PLUNGER
2	1	338345	END BEARING-MOTOR	29	1	431015	MOTOR COUPLING
3	1	306042	BRAKE PISTON	30	2	432018	FITTING
4	1	315004	CABLE ANCHOR	31	4	438022	BRAKE DISC
5	1	334177	RING GEAR	32	1	442220	GASKET-BRAKE HOUSING
6	1	338297	END BEARING-GEAR HOUSING	33	2	442223	GASKET-MOTOR FLANGE
7	1	338302	BRAKE HOUSING	34	1	456038	FITTING-VENT, BREATHER
8	4	346045	PIN-BRAKE	35	1	458142	MOTOR-18.7 CU.IN.
9	2	350720	TIE PLATE	36	1	458144	MOTOR-14.9 CU.IN.
10	1	357179	INPUT SHAFT	37	1	462056	O-RING (SHAFT)
11	4	362296	SPACER-TIE PLATE	38	1	462057	O-RING
12	2	362297	SPACER-FOOT	39	1	462058	O-RING
13	1	362298	SPACER-MOTOR	40	1	462059	BACKUP RING
14	1	402120	BEARING	41	1	462060	BACKUP RING
15	1	402121	BEARING	42	1	462061	O-RING (DRUM)
16	1	412095	BUSHING-MOTOR END	43	1	472052	PLUG
17	1	412096	BUSHING-GEAR HOUSING	44	5	474111	PLATE-SEPARATOR
18	6	414303	BOLT-3/8-16NC X2 1/2,HXHD,GR-5, ZINC	45	1	486101	SEAL-GEAR HOUSING
19	8	414658	BOLT-5/8-11NCX1 1/2LG,HXHD,GR-5, ZINC	46	1	490037	SNAP RING
20	1	414926	SETSCREW-3/8-16NC X1, SOCKET, NYLON	47	6	494110	SPRING-BRAKE
21	3	414935	CAPSCREW-3/8-16NCX2 1/2,HXSOCHD	48	4	494112	SPRING
22	2	414952	CAPSCREW-1/2-13NCX1 1/2LG,SOCHD, ZINC	49	1	509130	BRAKE TUBE
23	1	416016	SETSCREW1/4-20NCX1/4 HX SOCK HD CUP	50	1	516011	VALVE-MOTOR CONTROL
24	1	416080	SETSCREW-5/8-18NF X1 LG,HXSOCHD,CUP	51	1	518037	THRUST WASHER
25	1	418036	NUT-3/8-16 NC,HEX JAM, ZINC	52	1	518047	THRUST WASHER
26	1	418088	NUT-JAM 5/8-18NF HEX HD, ZINC	53	1	518052	THRUST WASHER
27	2	418218	LOCKWASHER-1/2 ID MED SECT, ZINC	54	1	518053	THRUST WASHER
						518054	THRUST WASHER

# KITS AND MAINTENANCE PARTS

123332

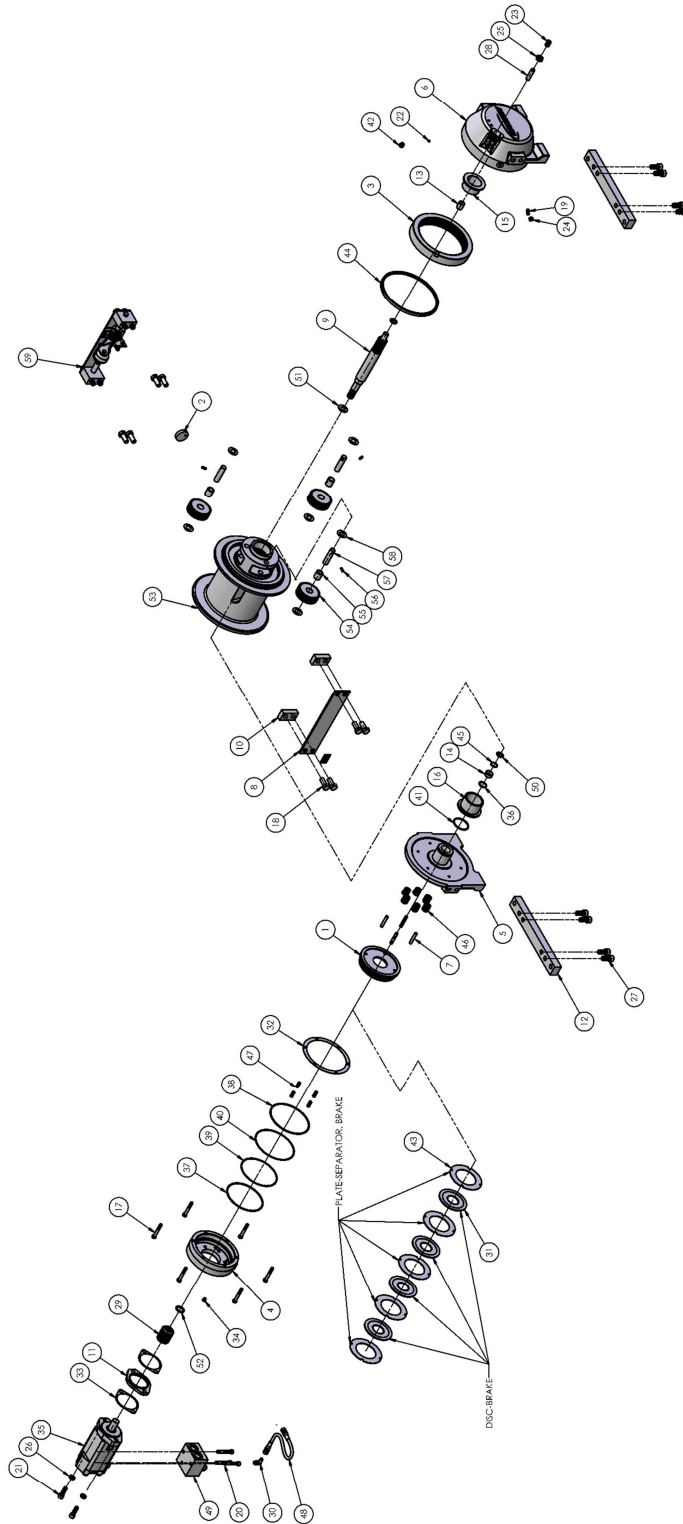

## KITS AND MAINTENANCE PARTS

123332

Item#	QTY.	PART NUMBER	DESCRIPTION							
				207021	222076	207026	246062	248051	283084	293024
1	1	306042	PISTON-BRAKE	X						
2	1	315004	ANCHOR- CABLE							
3	1	334256	GEAR-RING							
4	1	338302	HSG-BRAKE							
5	1	338345	END BEARING-MOTOR							
6	1	338414	END BEARING-GEAR HOUSING							
7	4	346045	PIN-BRAKE, .375 DIA.X2.125 LG.	X						
8	1	350720	PLATE-TIE							
9	1	357179	SHAFT-INPUT							
10	2	362296	SPACER-TIE PLATE							
11	1	362298	SPACER-MOTOR							
12	2	362334	SPACER-FOOT, WRAP INDICATOR							
13	1	402120	BEARING-GARLOK BRG					X		
14	1	402121	BEARING-GARLOCK BRG					X		
15	1	412110	BUSHING-DRUM, GEAR END					X		
16	1	412111	BUSHING-DRUM, MOTOR END					X		
17	6	414303	BOLT-3/8-16NC X2 1/2,HXHD,GR-5							
18	8	414658	BOLT-5/8-11NCX1 1/2LG,HXHD, GR.5							
19	1	414926	SETSCREW-3/8-16NC X1, SOCKET							
20	3	414935	CAPSCREW-3/8-16NCX2 1/2,HXSOCHD							
21	2	414952	CAPSCREW-1/2-13NCX1 1/2LG,SOCHD							
22	1	416016	SETSCREW 1/4-20NCX1/4 HX SOCK HD							
23	1	416080	SETSCREW-5/8-18NF X1 LG,HXSOCHD,CUP		X					
24	1	418036	NUT-3/8-16 NC,HEX JAM							
25	1	418088	NUT-JAM 5/8-18NF HEX HD		X					
26	2	418218	LOCKWASHER-1/2 ID MED SECT							
27	8	420013	CAPSCREW-5/8-11UNC X 1-1/4L, HEX SOC HD							
28	1	426048	PLUNGER-CLUTCH		X					
29	1	431015	COUPLING-MOTOR	X					X	
30	1	432018	FITTING C5OX-S T-LOK, 7/16-20 90 degree							
31	4	438022	DISC-BRAKE			X				
32	1	442220	GASKET-BRAKE HSG			X	X			
33	2	442223	GASKET-MOTOR FLANGE			X	X		X	
34	1	456038	FITTING-VENT,BREATHER							
35	1	458144	MOTOR-HYDRAULIC							
36	1	462056	O-RING, 1.26 OD				X			
37	1	462057	O-RING, 6.01 OD			X	X			
38	1	462058	O-RING, 6.51 OD			X	X			
39	1	462059	RING-BACK-UP, 5.59 OD			X	X			
40	1	462060	RING-BACK-UP, 6. 48 OD			X	X			

## KITS AND MAINTENANCE PARTS

123332

Item#	QTY.	PART NUMBER	DESCRIPTION							
				207021	222076	207026	246062	248051	283084	293024
41	1	462061	O-RING, 2.50 O.D.				X			
42	1	472052	PLUG-SAE O-RING,.562-18NF							
43	5	474111	PLATE-SEPARATOR,BRAKE			X				
44	1	486101	SEAL-V RING				X			
45	1	490037	SNAP RING							
46	6	494110	SPRING-BRAKE			X				
47	4	494112	SPRING			X				
48	1	509130	HOSE ASSY-HYD BRAKE RELEASE							
49	1	516011	VALVE-MTR CONTROL							
50	2	518037	THRUST WASHER					X		
51	1	518047	WASHER-THRUST,.063 THK.X1.50 OD					X		
52	1	518052	WASHER-THRUST,1.37 O.D.			X		X		
53	1	332290	DRUM-CABLE							X
54	3	334178	GEAR-PLANET,OUTPUT							X
55	3	412089	BUSHING-PLANET,OUTPUT							X
56	3	470086	ROLL PIN-1/4 X 11/16LG							X
57	3	470090	PIN-PLANET							X
58	6	518047	WASHER-THRUST,.063 THK.X1.50 OD							X
59	1	299759	ASSEMBLY-3 WRAP INDICATOR							

# KITS AND MAINTENANCE PARTS

## THIRD WRAP INDICATOR 299759

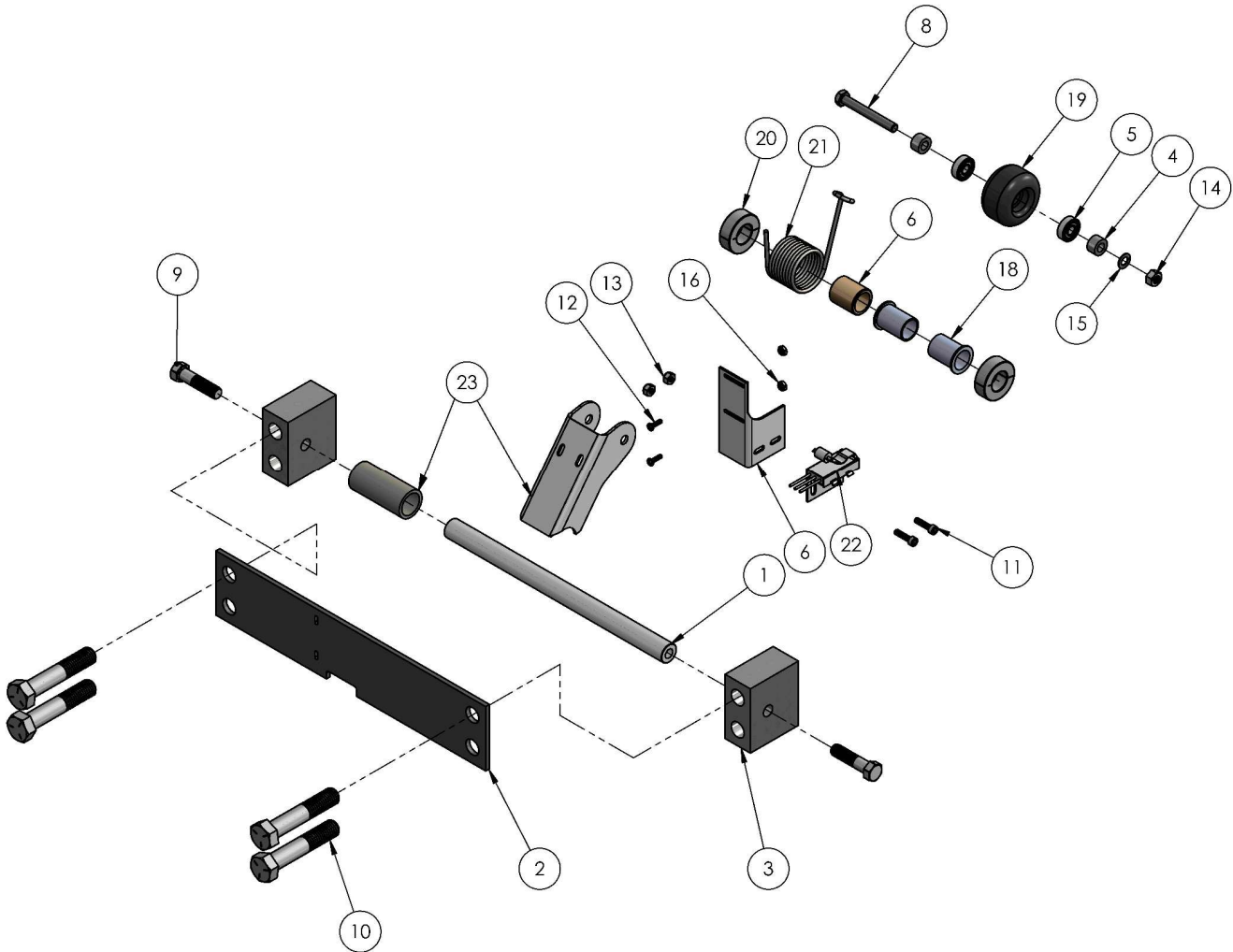

## KITS AND MAINTENANCE PARTS

### THIRD WRAP INDICATOR 299759

					KIT
Item#	QTY.	PARENT PART	PART NUMBER	DESCRIPTION	207020
1	1	299759	346054	BAR-PIVOT	
2	1	299759	350750	TIE PLATE-3 WRAP INDICATOR	
3	2	299759	362332	SPACER-TIE PLATE	
4	2	299759	362333	SPACER-WHEEL, 5/8OD X .344ID X 3/8LG	X
5	2	299759	402396	BEARING-BALL	X
6	1	299759	408432	BRACKET-MICRO SWITCH	X
7	1	299759	412083	BUSHING-PLANET,OUTPUT	X
8	1	299759	414159	CS-5/16-18UNCX2.50,HXHD,GR5	X
9	2	299759	414470	CAPSCREW-7/16-14NCX1 3/4LG,GR.5	
10	4	299759	414660	BOLT-5/8-11NCX3 1/4LG,HXHD,GR.5	X
11	2	299759	416262	SCREW-#10-32NF X3/4,HXSOC	X
12	2	299759	416284	SCREW-#6-32UNC X 1/2L	X
13	2	299759	418002	NUT-#10-32NF SELF-LOCKING	X
14	1	299759	418022	NUT-5/16-18NC HEX REG	X
15	1	299759	418163	LOCKWASHER-5/16 MED SECT	X
16	2	299759	418538	NUT-HEX, #6-32UNC	X
17	2	299759	418539	WASHER-LOCK	
18	2	299759	472091	BEARING-FLANGED. 3/4ID X 7/8OD X 1-1/4L	X
19	1	299759	472092	WHEEL-ARM, DURA ROLLER 52MM	X
20	2	299759	479017	COLLAR-SPLIT	X
21	1	299759	494141	SPRING-TORSION	X
22	1	299759	504029	SWITCH	X
22	1	299759	265116	WELDMENTIARM	

# KITS AND MAINTENANCE PARTS

123419

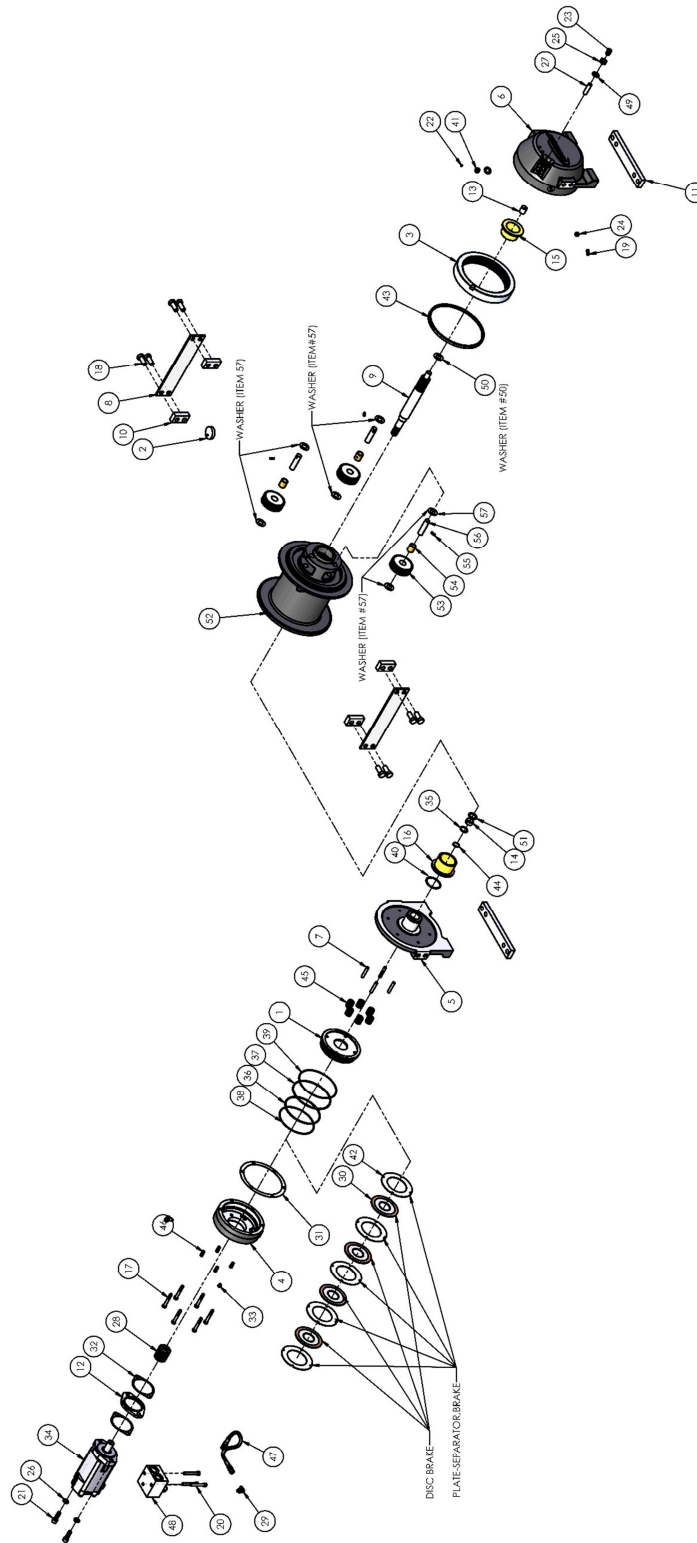

## KITS AND MAINTENANCE PARTS

123419

Item#	QTY.	PART NUMBER	DESCRIPTION	KITS					
				207021	207026	222076	246062	248051	293024
1	1	306042	PISTON-BRAKE	X					
2	1	315004	ANCHOR- CABLE						
3	1	334256	GEAR-RING						
4	1	338302	HSG-BRAKE						
5	1	338345	END BEARING-MOTOR						
6	1	338414	END BEARING-GEAR HOUSING						
7	4	346045	PIN-BRAKE,.375 DIA.X2.125 LG.	X					
8	2	350720	PLATE-TIE						
9	1	357179	SHAFT-INPUT						
10	4	362296	SPACER-TIE PLATE						
11	2	362297	SPACER-FOOT						
12	1	362298	SPACER-MOTOR						
13	1	402120	BEARING-GARLOK BRG					X	
14	1	402121	BEARING-GARLOCK BRG					X	
15	1	412110	BUSHING-DRUM, GEAR END					X	
16	1	412111	BUSHING-DRUM, MOTOR END					X	
17	6	414303	BOLT-3/8-16NC X2 1/2,HXHD,GR-5						
18	8	414658	BOLT-5/8-11NCX1 1/2LG,HXHD						
19	1	414926	SETSCREW-3/8-16NC X1,SOCKET						
20	3	414935	CAPSCREW-3/8-16NCX2 1/2,HXSOCHD						
21	2	414952	CAPSCREW-1/2-13NCX1 1/2LG,SOCHD						
22	1	416016	SETSCREW 1/4-20NCX1/4 HX SOCK HD CUP						
23	1	416080	SETSCREW-5/8-18NF X1 LG,HXSOCHD,CUP			X			
24	1	418036	NUT-3/8-16 NC,HEX JAM						
25	1	418088	NUT-JAM 5/8-18NF HEX HD			X			
26	2	418218	LOCKWASHER-1/2 ID MED SECT						
27	1	426048	PLUNGER-CLUTCH			X			
28	1	431015	COUPLING-MOTOR	X					
29	2	432018	FITTING C5OX-S T-LOK, 7/16-20 90 degree						
30	4	438022	DISC-BRAKE		X				
31	1	442220	GASKET-BRAKE HSG		X		X		
32	2	442223	GASKET-MOTOR FLANGE		X		X		
33	1	456038	FITTING-VENT,BREATHER						
34	1	458142	MOTOR-HYDRAULIC						
35	1	462056	O-RING, 1.26 OD				X		

## KITS AND MAINTENANCE PARTS

123419

Item#	QTY.	PART NUMBER	DESCRIPTION	KITS					
				207021	207026	222076	246062	248051	293024
36	1	462057	O-RING, 6.01 OD		X		X		
37	1	462058	O-RING, 6.51 OD		X		X		
38	1	462059	RING-BACK-UP, 5.59 OD		X		X		
39	1	462060	RING-BACK-UP, 6.48 OD		X		X		
40	1	462061	O-RING, 2.50 O.D.				X		
41	1	472052	PLUG-SAE O-RING, .562-18NF						
42	5	474111	PLATE-SEPARATOR, BRAKE		X				
43	1	486101	SEAL-V RING				X		
44	1	490037	SNAP RING						
45	6	494110	SPRING-BRAKE		X				
46	4	494112	SPRING		X				
47	1	509130	HOSE ASSY-HYD BRAKE RELEASE						
48	1	516011	VALVE-MTR CONTROL						
49	2	518037	THRUST WASHER, 1.15 OD					X	
50	1	518047	WASHER-THRUST, .063 THK.X1.50 OD					X	
51	1	518052	WASHER-THRUST, 1.37 O.D., RPH-12000		X			X	
52	1	332290	DRUM-CABLE						X
53	3	334178	GEAR-PLANET, OUTPUT						X
54	3	412089	BUSHING-PLANET, OUTPUT						X
55	3	470086	ROLL PIN-1/4 X 11/16LG						X
56	3	470090	PIN-PLANET						X
57	6	518047	WASHER-THRUST, .063 THK.X1.50 OD						X

**RAMSEY WINCH INDUSTRIAL WINCH  
LIMITED WARRANTY**

**1.1 Scope of Warranty Coverage.** Upon the terms and subject to the conditions set forth in this limited warranty:

- (a) RAMSEY WINCH (referred to herein as “**RAMSEY WINCH**” or the “**Manufacturer**”) warrants to each initial end user customer (a “**Purchaser**”) of a new industrial winch together with any accessories manufactured and sold directly from RAMSEY WINCH (the “**Product**”) that the Product shall be free from defects in material and workmanship, under normal working and service conditions, for a period of eighteen (18) months from the date the Product is shipped from RAMSEY WINCH. (the “**Warranty Term**”). A Purchaser shall be eligible for an additional eighteen (18) months of coverage in addition to the Warranty Term (also referred to as the “**Standard (+) PLUS benefit**”) only if the Purchaser (i) complies with Section 1.2(a) and (ii) registers the Product during the Warranty Term at [myproduct.ramseywinch.com](http://myproduct.ramseywinch.com).
- (b) Notwithstanding the foregoing, this warranty does not cover components damaged by accident, abuse, misuse, neglect, untrained operators, collision, overloading, modification, disassembly, rework, misapplication, improper installation, lack of lubrication or maintenance, or improper service. This warranty does not cover the paint or material finish, rope (wire or synthetic), removal or reinstallation of the winch, or normal wear and tear and loss of functionality due to aging of the Product (which may include but is not limited to bearings, bushings, seals, O-rings, gaskets, brake material, motor brushes, electrical cables and more).

**1.2 Eligibility of Warranty Coverage.**

- (a) A Purchaser shall be eligible for warranty coverage under this Limited Warranty during the Warranty Term only if:
  - (i) Prior to placing a Product in service, and throughout use of the Product during the Warranty Term, the Purchaser provides (or causes to be provided) proper storage such that foreign objects (e.g. rain or debris) cannot enter any Product through entry ports which are normally closed during operation.; and
  - (ii) The Purchaser maintains, or causes to be maintained, the Product according to commercially reasonable standards and utilizes the Product for the purposes for which it was created; and
  - (iii) No repairs or alterations have been made by any party other than RAMSEY WINCH, including Purchaser, unless otherwise authorized in writing by RAMSEY WINCH.

**1.3 Transferability of Warranty.**

- (a) This warranty is transferable only from the Purchaser to the first subsequent transferee (the “**Transferee**”) of the Product from Purchaser upon (i) written notification to RAMSEY WINCH and (ii) registration of the transfer, both within 30 days of such Product transfer.
- (b) Upon satisfaction of transfer requirements set forth in Section 1.3(a), the Transferee shall succeed to all the rights and obligations of the Purchaser set forth in this Limited Warranty.

**1.4 Certain Limitations on Scope of Warranty Service.**

- (a) Any obligation of RAMSEY WINCH under this warranty, statutory or otherwise, is limited to the repair of the Product, at its factory or Authorized Service Centers. Notwithstanding the foregoing, if field service or repair is performed by RAMSEY WINCH at the request of the Purchaser and no defect is found with material or workmanship of the Product, the Purchaser shall compensate RAMSEY WINCH for its time and expenses within thirty (30) days of delivery of an invoice relating to the same. If repair is determined by RAMSEY WINCH in its sole, absolute and uncontrolled discretion to be impossible or impractical, then RAMSEY WINCH may satisfy this warranty by replacing the Product. RAMSEY WINCH will not provide any cash payment or credits for defective materials or workmanship.

- (b) Purchaser shall be responsible for any and all freight charges for any Product receiving warranty service under this limited warranty. Any travel time, transportation charges, freight charges, or similar costs incurred by RAMSEY WINCH in connection with the replacement or repair of defective parts, shall, be the responsibility of the Purchaser. If applicable, RAMSEY WINCH shall invoice Purchaser for the total amount of such charges within sixty (60) days of fulfilling its duties under this warranty, payable within thirty (30) days of delivery of such invoice. In no event shall RAMSEY WINCH be liable for bills for service, labor or other expenses that have been incurred by the Purchaser without approval or prior authorization by RAMSEY WINCH for inspection, maintenance, or repair of the Product.
- (c) If a Product is found to be operable upon inspection, the Product, at Purchaser's election, may be either (1) returned to the Purchaser with a service charge from RAMSEY WINCH for inspection, cleaning, and routine replacement of all rubber components and any other parts that show wear; or (2) RAMSEY WINCH can dispose of the product safely.

1.5 **Limitations of Liability.** RAMSEY WINCH shall in no event be liable for punitive, special or consequential damages relating to the Product or this Warranty. RAMSEY WINCH makes no warranty in respect to third-party accessories, upgrades, or additions to the Product.

1.6 **Improving Product.** RAMSEY WINCH reserves the right to improve the Product through changes in design or materials as it may deem desirable or necessary without being obligated to incorporate, upgrade, or otherwise modify previously manufactured products.

1.7 **Limitations of Warranty.**

- (a) THE WARRANTY SET FORTH ABOVE IS THE ONLY EXPRESS WARRANTY. RAMSEY WINCH HEREBY DISCLAIMS AND EXCLUDES ANY OTHER EXPRESS, IMPLIED, OR STATUTORY WARRANTIES, ARISING BY OPERATION OF LAW, COURSE OF DEALING, COURSE OF PERFORMANCE, USAGE, OF TRADE, OR OTHERWISE, INCLUDING, WITHOUT LIMITATION, ANY WARRANTIES OF MERCHANTABILITY, FITNESS FOR A PARTICULAR PURPOSE, AND INTELLECTUAL PROPERTY RIGHTS OF A THIRD PARTY.
- (b) ANY IMPLIED WARRANTY WHICH BY LAW MAY NOT BE EXCLUDED IS LIMITED IN DURATION TO ONE (1) YEAR FROM THE DATE OF ORIGINAL RETAIL PURCHASE OF THE PRODUCT.
- (c) This warranty gives you specific legal rights, and you may also have other rights which vary from jurisdiction to jurisdiction.
- (d) This warranty is valid only in the U.S.A. and Canada. For warranty outside the U.S.A. and Canada contact your nearest Ramsey Winch Distributor.

1.8 **No Modifications to Warranty.** No RAMSEY WINCH dealer, distributor, agent or employee is authorized to make any modification, extension or addition to this warranty.

1.9 **How to Apply for Warranty Coverage.**

All claims are handled by contacting your nearest Ramsey Winch Distributor. For questions, please contact customer support: [rwcustomersupport@ramseyindustries.com](mailto:rwcustomersupport@ramseyindustries.com).

Visit [Dealer Locator - Ramsey Winch](#) for Ramsey Winch Distributor locations and contact information.

Additional warranty, service support, product information, and parts information can be found on [www.ramseywinch.com](http://www.ramseywinch.com).

## NOTES



**Ramsey Winch Company**

Post Office Box 581510

Tulsa, Oklahoma 74158-1510

Telephone: (#918) 438-2760

FAX: (#918) 438-6688